

TEST REPORT EN 60950-1 Safety of information technology equipment Part 1-General requirements	
Report reference No	RSZ160302004-03A1
Compiled by (+ signature)	Joe Kwong <i>Joe Kwong</i>
Approved by (+ signature)	Safety Engineer: Ryan Zhang <i>Ryan Zhang</i>
Date of issue	2016-03-14
Testing laboratory	Bay Area Compliance Laboratories Corp. (Shenzhen)
Address	6/F, the 3rd Phase of WanLi Industrial Building, ShiHua Road, FuTian Free Trade Zone, ShenZhen, Guangdong, P.R.China
Testing location	As above
Applicant's name	Advanced Technologies SRL.
Address	Ion Heliade Radulescu nr 26, Bucharest 021255, ROMANIA
Manufacturer's name.....	Shenzhen East Xinyi Electronic Techonology Co., Ltd
Address	Room 20A, TAIBANG Techonology bldg, High-Tech Park, Nanshan District, Shenzhen, China
Factory's name.....	Same as manufacturer
Address	Same as manufacturer
Standard	EN 60950-1:2006+A11:2009+A1:2010+A12:2011+A2:2013
Test sample(s) received.....	2015-12-10
Test in period.....	2015-12-11 To 2015-12-31
Procedure deviation	N.A.
Non-standard test method	N.A.
This test report is for the customer shown above and their specific product only. It may not be duplicated or used in part without prior written consent from Bay Area Compliance Laboratories Corp. (Shenzhen).	
Type of test object	Smartphone
Trademark	vonino
Test model	ZUN X
Manufacturer	Shenzhen East Xinyi Electronic Techonology Co., Ltd
Rating	5.0V $\overline{\text{---}}$ 1000 mA (Built-in a 3.8V/2200mAh Li-ion rechargeable battery)

Copy of marking plate:

Smartphone

vonino

Model: ZUN X

Rating: 5.0V $\overline{\text{---}}$ 1000 mA (Built-in a 3.8V/2200mAh Li-ion rechargeable battery)

Use only power supply listed in the manual

CE1313 

Made in China

FINNAL

Test item particulars	
Equipment mobility	<input type="checkbox"/> movable <input checked="" type="checkbox"/> hand-held <input type="checkbox"/> transportable <input type="checkbox"/> stationary <input type="checkbox"/> for building-in <input type="checkbox"/> direct plug-in
Connection to the mains	<input type="checkbox"/> pluggable equipment <input type="checkbox"/> type A <input type="checkbox"/> type B <input type="checkbox"/> detachable power supply cord <input type="checkbox"/> non-detachable power supply cord <input checked="" type="checkbox"/> not directly connected to the mains
Operating condition	<input checked="" type="checkbox"/> continuous <input type="checkbox"/> rated operating / resting time:
Access location	<input checked="" type="checkbox"/> operator accessible <input type="checkbox"/> restricted access location
Over voltage category (OVC)	<input checked="" type="checkbox"/> OVC I <input type="checkbox"/> OVC II <input type="checkbox"/> OVC III <input type="checkbox"/> OVC IV <input type="checkbox"/> other:
Mains supply tolerance (%)	N/A
Tested for IT power systems	<input type="checkbox"/> Yes <input checked="" type="checkbox"/> No
IT testing, phase-phase voltage (V)	N/A
Class of equipment	<input type="checkbox"/> Class I <input type="checkbox"/> Class II <input checked="" type="checkbox"/> Class III <input type="checkbox"/> Not classified
Considered current rating of protective device as part of the building installation (A)	N/A
Pollution degree (PD)	<input type="checkbox"/> PD 1 <input checked="" type="checkbox"/> PD 2 <input type="checkbox"/> PD 3
IP protection class	IP20
Altitude during operation (m)	Up to 2000
Altitude of test laboratory (m)	Below 2000
Laser or LED Classification	Exempt Group For LED Classification
Max. Specified ambient temperature(°C)	40°C
Mass of equipment (kg)	Approx 0.140kg (without accessories)
Possible test case verdicts	
- test case does not apply to the test object	
- test object does meet the requirement	
- test object does not meet the requirement	
General remarks:	
"(see remark #)" refers to a remark appended to the report. (see appended table)" refers to a table appended to the report. The test results presented in this report relate only to the object tested. This report shall not be reproduced except in full without the written approval of the testing laboratory. Throughout this report a <input type="checkbox"/> comma/ <input checked="" type="checkbox"/> point is used as the decimal separator.	

General product information:

1.1 The products under test is a Smartphone that classified as class III equipment and built in rechargeable Li-ion battery rated 3.8V/2200mAh. It is being charged with an approved adapter which complied with LPS.

See appended table 1.5.1

1.2 The follows are stated and guarantee by applicant:

All test data come from report RSZ151208012-03 issued by BACL, except 1.6.2., because only change the adaptor. Compared with original report, only change the applicant, the manufacturer, the product name, the model name and the trademark on reports and certificate. No other changes are made to them.

FINAL

EN 60950-1			
Clause	Requirement + Test	Result - Remark	Verdict
1	General		P
1.5	Components		P
1.5.1	General		P
	Comply with IEC60950-1 or relevant component standard	Components that were found to affect safety aspects comply with the requirements of this standard or within the safety aspects of the relevant IEC component standards. (see appended table 1.5.1)	P
1.5.2	Evaluation and testing of components	Certified components are used in accordance with their ratings, certifications and they comply with applicable parts of this Standard. Components not certified are used in accordance with their ratings and they comply with IEC60950-1 and the relevant component Standard.	P
1.5.3	Thermal controls	No thermal controls	N
1.5.4	Transformers	Evaluated in approved adapter	N
1.5.5	Interconnecting cables	The interconnecting cables contain only SELV.	P
1.5.6	Capacitors bridging insulation	Class III equipment. Evaluated in approved adapter	N
1.5.7	Resistors bridging insulation	Class III equipment.	N
1.5.7.1	Resistors bridging functional, basic or supplementary insulation		N
1.5.7.2	Resistors bridging double or reinforced insulation between a.c. mains and other circuits	Not used.	N
1.5.7.3	Resistors bridging double or reinforced insulation between a.c. mains and antenna or coaxial cable	Not used.	N
1.5.8	Components in equipment for IT power systems	Not intend for IT power distribution systems.	N
1.5.9	Surge suppressors		N
1.5.9.1	General		N
1.5.9.2	Protection of VDRs		N
1.5.9.3	Bridging of functional insulation by a VDR		N
1.5.9.4	Bridging of basic insulation by a VDR		N
1.5.9.5	Bridging of supplementary, double or reinforced insulation by a VDR		N

EN 60950-1			
Clause	Requirement + Test	Result - Remark	Verdict
1.6	Power interface		P
1.6.1	AC power distribution systems	The equipment is regarded as class III equipment.	N
1.6.2	Input current	(see appended table 1.6.2)	P
1.6.3	Voltage limit of hand-held equipment	The rated voltage of the equipment does not exceed 250V	P
1.6.4	Neutral conductor	Class III equipment.	N

1.7	Marking and instructions		P
1.7.1	Power rating and identification markings		P
1.7.1.1	Power rating marking		P
	Multiple mains supply connections.....:		N
	Rated voltage(s) or voltage range(s) (V)	5.0 V	P
	Symbol for nature of supply, for d.c. only	---	P
	Rated frequency or rated frequency range (Hz).....:		N
	Rated current (mA or A)	1000 mA	P
1.7.1.2	Identification markings		P
	Manufacturer's name or trade-mark or identification mark	Trade-mark: vonino	P
	Model identification or type reference	ZUN X	P
	Symbol for Class II equipment only	Class III equipment	N
	Other markings and symbols	CE1313	P
1.7.1.3	Use of graphical symbols	EUT is not a PERMANENTLY CONNECTED EQUIPMENT	N
1.7.2	Safety instructions and marking	Operating/safety instructions made available to the user.	P
1.7.2.1	General		N
1.7.2.2	Disconnect devices	Class III equipment	N
	-for permanently connected equipment, a readily accessible disconnect device shall be incorporated in the building installation wiring	Neither a PLUGGABLE EQUIPMENT TYPE B nor a PERMANENTLY CONNECTED EQUIPMENT	N
	-for pluggable equipment, the socket-outlet shall be installed near the equipment and shall be easily accessible		N
1.7.2.3	Overcurrent protective device	Neither a PLUGGABLE EQUIPMENT TYPE B nor a PERMANENTLY CONNECTED EQUIPMENT	N
1.7.2.4	IT power distribution systems	Class III equipment	N
1.7.2.5	Operator access with a tool		N

EN 60950-1			
Clause	Requirement + Test	Result - Remark	Verdict
1.7.2.6	Ozone	No ozone produced	N
1.7.3	Short duty cycles	Continuous operation.	N
1.7.4	Supply voltage adjustment	No voltage selector	N
	Methods and means of adjustment; reference to installation instructions		N
1.7.5	Power outlets on the equipment	No standard power outlet.	N
1.7.6	Fuse identification (marking, special fusing characteristics, cross-reference)		N
1.7.7	Wiring terminals		N
1.7.7.1	Protective earthing and bonding terminals	No protective earthing and bonding terminals	N
1.7.7.2	Terminals for a.c. mains supply conductors	The equipment not for permanent connection or provided with a non-detachable power supply cord	N
1.7.7.3	Terminals for d.c. mains supply conductors	The equipment not intended to be connected to DC mains	N
1.7.8	Controls and indicators	LED indicators provided	P
1.7.8.1	Identification, location and marking	Such marking do not affect safety.	P
1.7.8.2	Colours	For functional indication a LED lights when the equipment is operating.	P
1.7.8.3	Symbols according to IEC 60417	The equipment not intended to be connected to DC mains	N
1.7.8.4	Markings using figures		N
1.7.9	Isolation of multiple power sources	Single DC source input.	N
1.7.10	Thermostats and other regulating devices	No thermostats or other regulating devices	N
1.7.11	Durability	Rubbed with a cloth soaked with water for 15s then again for 15s with cloth soaked with petroleum spirit, after this test, the marking on the label did not fade there are no curling nor lifting of the label edge.	P
1.7.12	Removable parts	No marking located on a removable part.	N

EN 60950-1			
Clause	Requirement + Test	Result - Remark	Verdict
1.7.13	Replaceable batteries	Built-in a 3.8V/2200mAh rechargeable Li-ion battery. Relevant warning marking is both in the operation and service manual. The require warning marking is both in operation and service manuals: Please use appointed battery in case of explosion risk, please dispose of lifeless battery under guidance.	P
	Language(s)	English	—
1.7.14	Equipment for restricted access locations.....		N

2	Protection from hazards		P
2.1	Protection from electric shock and energy hazards		P
2.1.1	Protection in operator access areas	Class III equipment, and no energy hazards in access areas. See below	N
2.1.1.1	Access to energized parts		P
	Test by inspection		N
	Test with test finger (Figure 2A)		N
	Test with test pin (Figure 2B)		N
	Test with test probe (Figure 2C)	No TNV circuits	N
2.1.1.2	Battery compartments		N
2.1.1.3	Access to ELV wiring	No ELV wiring in operator accessible area	N
	Working voltage (V_{peak} or V_{rms}); minimum distance through insulation (mm)		—
2.1.1.4	Access to hazardous voltage circuit wiring		N
2.1.1.5	Energy hazards	No energy hazards presents in operator access area. see appended table 2.1.1.5 c)1)	P
2.1.1.6	Manual controls		N
2.1.1.7	Discharge of capacitors in equipment		N
	Measured voltage (V); time-constant (s)		—
2.1.1.8	Energy hazards – d.c. mains supply		N
	a) Capacitor connected to the d.c. mains supply ...		N
	b) Internal battery connected to the d.c. mains supply		N
2.1.1.9	Audio amplifiers		N
2.1.2	Protection in service access areas	No bare parts operating at HAZARDOUS VOLTAGES in a service access area.	P

EN 60950-1			
Clause	Requirement + Test	Result - Remark	Verdict

2.1.3	Protection in restricted access locations	Equipment not intended for installation in restricted access locations	N
-------	---	--	---

2.2	SELV circuits		P
2.2.1	General requirements	Equipment supplied by SELV source.	P
2.2.2	Voltages under normal conditions (V)	Not exceed SELV limit	P
2.2.3	Voltages under fault conditions (V)	Not exceed SELV limit	P
2.2.4	Connection of SELV circuits to other circuits	SELV separated from Primary by Reinforced insulation. Evaluated as part of Power Supply Certification.	P

2.3	TNV circuits	<i>No TNV circuits</i>	N
2.3.1	Limits		N
	Type of TNV circuits		—
2.3.2	Separation from other circuits and from accessible parts		N
2.3.2.1	General requirements		N
2.3.2.2	Protection by basic insulation		N
2.3.2.3	Protection by earthing		N
2.3.2.4	Protection by other constructions		N
2.3.3	Separation from hazardous voltages		N
	Insulation employed.....		—
2.3.4	Connection of TNV circuits to other circuits		N
	Insulation employed.....		—
2.3.5	Test for operating voltages generated externally		N

2.4	Limited current circuits	<i>No limited current circuits</i>	N
2.4.1	General requirements		N
2.4.2	Limit values		N
	Frequency (Hz).....		—
	Measured current (mA).....		—
	Measured voltage (V)		—
	Measured circuit capacitance (nF or μ F).....		—
2.4.3	Connection of limited current circuits to other circuits		N

2.5	Limited power sources		P
------------	------------------------------	--	----------

EN 60950-1			
Clause	Requirement + Test	Result - Remark	Verdict
	a) Inherently limited output		N
	b) Impedance limited output		N
	c) Regulating network limited output under normal operating and single fault condition	3.8V/2200mAh rechargable Li-ion batteries were subjected to test and complied with LPS limits.	P
	d) Overcurrent protective device limited output		N
	Max. output voltage (V), max. output current (A), max. apparent power (VA)		—
	Current rating of overcurrent protective device (A)		—
	Use of integrated circuit (IC) current limiters		N

2.6	Provisions for earthing and bonding		N
2.6.1	Protective earthing	Class III equipment.	N
2.6.2	Functional earthing		N
2.6.3	Protective earthing and protective bonding conductors		N
2.6.3.1	General		N
2.6.3.2	Size of protective earthing conductors		N
	Rated current (A), cross-sectional area (mm ²), AWG		—
2.6.3.3	Size of protective bonding conductors		N
	Rated current (A), cross-sectional area (mm ²), AWG		—
2.6.3.4	Resistance of earthing conductors and their terminations; resistance (Ω), voltage drop (V), test current (A), duration (min)		N
2.6.3.5	Colour of insulation		N
2.6.4	Terminals		N
2.6.4.1	General		N
2.6.4.2	Protective earthing and bonding terminals		N
	Rated current (A), type, nominal thread diameter (mm)		—
2.6.4.3	Separation of the protective earthing conductor from protective bonding conductors		N
2.6.5	Integrity of protective earthing		N
2.6.5.1	Interconnection of equipment		N
2.6.5.2	Components in protective earthing conductors and protective bonding conductors		N
2.6.5.3	Disconnection of protective earth		N
2.6.5.4	Parts that can be removed by an operator		N
2.6.5.5	Parts removed during servicing		N
2.6.5.6	Corrosion resistance		N

EN 60950-1			
Clause	Requirement + Test	Result - Remark	Verdict
2.6.5.7	Screws for protective bonding		N
2.6.5.8	Reliance on telecommunication network or cable distribution system		N

2.7	Overcurrent and earth fault protection in primary circuits		N
2.7.1	Basic requirements	Class III equipment	N
	Instructions when protection relies on building installation		N
2.7.2	Faults not simulated in 5.3.7		N
2.7.3	Short-circuit backup protection		N
2.7.4	Number and location of protective devices		N
2.7.5	Protection by several devices		N
2.7.6	Warning to service personnel.....		N

2.8	Safety interlocks		N
2.8.1	General principles	No safety interlocks	N
2.8.2	Protection requirements		N
2.8.3	Inadvertent reactivation		N
2.8.4	Fail-safe operation		N
	Protection against extreme hazard		N
2.8.5	Moving parts		N
2.8.6	Overriding		N
2.8.7	Switches, relays and their related circuits		N
2.8.7.1	Separation distances for contact gaps and their related circuits (mm)		N
2.8.7.2	Overload test		N
2.8.7.3	Endurance test		N
2.8.7.4	Electric strength test		N
2.8.8	Mechanical actuators		N

2.9	Electrical insulation		P
2.9.1	Properties of insulating materials	Natural rubber, asbestos or hygroscopic material not used	P
2.9.2	Humidity conditioning		N
	Relative humidity (%), temperature (°C)		—
2.9.3	Grade of insulation	Functional insulation	P
2.9.4	Separation from hazardous voltages	Have evaluated in the approved adapter	P
	Method(s) used	Method 1 used	—

EN 60950-1			
Clause	Requirement + Test	Result - Remark	Verdict
2.10	Clearances, creepage distances and distances through insulation		N
2.10.1	General	Class III equipment, functional insulation verified according to 5.3.4 c)	N
2.10.1.1	Frequency		N
2.10.1.2	Pollution degrees		N
2.10.1.3	Reduced values for functional insulation		N
2.10.1.4	Intervening unconnected conductive parts		N
2.10.1.5	Insulation with varying dimensions		N
2.10.1.6	Special separation requirements		N
2.10.1.7	Insulation in circuits generating starting pulses		N
2.10.2	Determination of working voltage		N
2.10.2.1	General		N
2.10.2.2	RMS working voltage		N
2.10.2.3	Peak working voltage		N
2.10.3	Clearances		N
2.10.3.1	General		N
2.10.3.2	Mains transient voltages		N
	a) AC mains supply		N
	b) Earthed d.c. mains supplies		N
	c) Unearthed d.c. mains supplies		N
	d) Battery operation		N
2.10.3.3	Clearances in primary circuits		N
2.10.3.4	Clearances in secondary circuits		N
2.10.3.5	Clearances in circuits having starting pulses		N
2.10.3.6	Transients from a.c. mains supply		N
2.10.3.7	Transients from d.c. mains supply		N
2.10.3.8	Transients from telecommunication networks and cable distribution systems		N
2.10.3.9	Measurement of transient voltage levels		N
	a) Transients from a mains supply		N
	For an a.c. mains supply		N
	For a d.c. mains supply		N
	b) Transients from a telecommunication network :		N
2.10.4	Creepage distances		N
2.10.4.1	General		N
2.10.4.2	Material group and comparative tracking index		N
	CTI tests		—
2.10.4.3	Minimum creepage distances		N

EN 60950-1			
Clause	Requirement + Test	Result - Remark	Verdict
2.10.5	Solid insulation		N
2.10.5.1	General		N
2.10.5.2	Distances through insulation		N
2.10.5.3	Insulating compound as solid insulation		N
2.10.5.4	Semiconductor devices		N
2.10.5.5.	Cemented joints		N
2.10.5.6	Thin sheet material – General		N
2.10.5.7	Separable thin sheet material		N
	Number of layers (pcs)		—
2.10.5.8	Non-separable thin sheet material		N
2.10.5.9	Thin sheet material – standard test procedure		N
	Electric strength test		—
2.10.5.10	Thin sheet material – alternative test procedure		N
	Electric strength test		—
2.10.5.11	Insulation in wound components		N
2.10.5.12	Wire in wound components		N
	Working voltage		N
	a) Basic insulation not under stress		N
	b) Basic, supplementary, reinforced insulation		N
	c) Compliance with Annex U		N
	Two wires in contact inside wound component; angle between 45° and 90°		N
2.10.5.13	Wire with solvent-based enamel in wound components		N
	Electric strength test		—
	Routine test		N
2.10.5.14	Additional insulation in wound components		N
	Working voltage		N
	- Basic insulation not under stress		N
	- Supplementary, reinforced insulation		N
2.10.6	Construction of printed boards		N
2.10.6.1	Uncoated printed boards		N
2.10.6.2	Coated printed boards		N
2.10.6.3	Insulation between conductors on the same inner surface of a printed board		N
2.10.6.4	Insulation between conductors on different layers of a printed board		N
	Distance through insulation		N
	Number of insulation layers (pcs).....		N

EN 60950-1			
Clause	Requirement + Test	Result - Remark	Verdict
2.10.7	Component external terminations		N
2.10.8	Tests on coated printed boards and coated components		N
2.10.8.1	Sample preparation and preliminary inspection		N
2.10.8.2	Thermal conditioning		N
2.10.8.3	Electric strength test		N
2.10.8.4	Abrasion resistance test		N
2.10.9	Thermal cycling		N
2.10.10	Test for Pollution Degree 1 environment and insulating compound		N
2.10.11	Tests for semiconductor devices and cemented joints		N
2.10.12	Enclosed and sealed parts		N

3	Wiring, connections and supply		P
3.1	General		P
3.1.1	Current rating and overcurrent protection	Class III equipment.	N
3.1.2	Protection against mechanical damage	Wireways are smooth and free from sharp edges	P
3.1.3	Securing of internal wiring	The wires are positioned in such a manner that prevents excessive strain, loosening of terminal connections and damage of conductor insulation.	P
3.1.4	Insulation of conductors		P
3.1.5	Beads and ceramic insulators		N
3.1.6	Screws for electrical contact pressure	No screws for electrical contact pressure	N
3.1.7	Insulating materials in electrical connections	No insulating materials in electrical connections	N
3.1.8	Self-tapping and spaced thread screws	No self-tapping and spaced thread screws for the connection of current-carrying	N
3.1.9	Termination of conductors		N
	10 N pull test		N
3.1.10	Sleeving on wiring	No sleeving	N

3.2	Connection to a mains supply		N
3.2.1	Means of connection	Class III equipment	N
3.2.1.1	Connection to an a.c. mains supply		N
3.2.1.2	Connection to a d.c. mains supply		N
3.2.2	Multiple supply connections		N

EN 60950-1			
Clause	Requirement + Test	Result - Remark	Verdict
3.2.3	Permanently connected equipment		N
	Number of conductors, diameter of cable and conduits (mm)		—
3.2.4	Appliance inlets		N
3.2.5	Power supply cords		N
3.2.5.1	AC power supply cords		N
	Type		—
	Rated current (A), cross-sectional area (mm ²), AWG		—
3.2.5.2	DC power supply cords		N
3.2.6	Cord anchorages and strain relief		N
	Mass of equipment (kg), pull (N)		—
	Longitudinal displacement (mm)		—
3.2.7	Protection against mechanical damage		N
3.2.8	Cord guards		N
	Diameter or minor dimension D (mm); test mass (g)		—
	Radius of curvature of cord (mm).....		—
3.2.9	Supply wiring space		N

3.3	Wiring terminals for connection of external conductors		N
3.3.1	Wiring terminals	Class III equipment	N
3.3.2	Connection of non-detachable power supply cords		N
3.3.3	Screw terminals		N
3.3.4	Conductor sizes to be connected		N
	Rated current (A), cord/cable type, cross-sectional area (mm ²).....		—
3.3.5	Wiring terminal sizes		N
	Rated current (A), type, nominal thread diameter (mm)		—
3.3.6	Wiring terminal design		N
3.3.7	Grouping of wiring terminals		N
3.3.8	Stranded wire		N

3.4	Disconnection from the mains supply		N
3.4.1	General requirement	Class III equipment	N
3.4.2	Disconnect devices		N
3.4.3	Permanently connected equipment		N
3.4.4	Parts which remain energized		N
3.4.5	Switches in flexible cords		N

EN 60950-1			
Clause	Requirement + Test	Result - Remark	Verdict
3.4.6	Number of poles - single-phase and d.c. equipment		N
3.4.7	Number of poles - three-phase equipment		N
3.4.8	Switches as disconnect devices		N
3.4.9	Plugs as disconnect devices		N
3.4.10	Interconnected equipment		N
3.4.11	Multiple power sources		N

3.5	Interconnection of equipment		P
3.5.1	General requirements		P
3.5.2	Types of interconnection circuits	SELV circuit.	P
3.5.3	ELV circuits as interconnection circuits		N
3.5.4	Data ports for additional equipment	No data port supplying power to additional equipment.	N

4	Physical requirements		P
4.1	Stability		N
	Angle of 10°	Equipment with mass not exceeding 7kg and nor a floor-standing	N
	Test force (N)		N

4.2	Mechanical strength		P
4.2.1	General		P
	Rack-mounted equipment.		N
4.2.2	Steady force test, 10 N		N
4.2.3	Steady force test, 30 N		N
4.2.4	Steady force test, 250 N		No hazard as a result of the test. P
4.2.5	Impact test		The EUT is a hand-held equipment and subjected to drop test, see 4.2.6 N
	Fall test		N
	Swing test		N
4.2.6	Drop test; height (mm)	1000mm drop test is applied three times on different directions, no hazards as a result of test.	P
4.2.7	Stress relief test		No indication of shrinkage or distortion on enclosure due to the stress relief test. (70 degree C/7hrs) P
4.2.8	Cathode ray tubes		N

EN 60950-1			
Clause	Requirement + Test	Result - Remark	Verdict
	Picture tube separately certified		N
4.2.9	High pressure lamps		N
4.2.10	Wall or ceiling mounted equipment; force (N)		N
4.2.11	Rotating solid media		N
	Test to cover on the door.....		N

4.3	Design and construction		P
4.3.1	Edges and corners	All coners are smooth and rounded	P
4.3.2	Handles and manual controls; force (N).....		N
4.3.3	Adjustable controls		N
4.3.4	Securing of parts	No loosening of parts impairing creepage distances or clearances is likely to occur.	P
4.3.5	Connection by plugs and sockets	No plug or socket	P
4.3.6	Direct plug-in equipment		N
	Torque		—
	Compliance with the relevant mains plug standard		N
4.3.7	Heating elements in earthed equipment	No heating elements	N
4.3.8	Batteries	Built in a 3.8V/2200mAh rechargeable Li-ion battery, see appended table 1.5.1	P
	- Overcharging of a rechargeable battery		P
	- Unintentional charging of a non-rechargeable battery		N
	- Reverse charging of a rechargeable battery	Can't be reversed according to the design of enclosure and connector.	N
	- Excessive discharging rate for any battery	See appended table 4.3.8	P
4.3.9	Oil and grease	No oil and grease	N
4.3.10	Dust, powders, liquids and gases		N
4.3.11	Containers for liquids or gases		N
4.3.12	Flammable liquids		N
	Quantity of liquid (l)		N
	Flash point (°C)		N
4.3.13	Radiation		P
4.3.13.1	General		P
4.3.13.2	Ionizing radiation		N
	Measured radiation (pA/kg)		—

EN 60950-1			
Clause	Requirement + Test	Result - Remark	Verdict
	Measured high-voltage (kV)		—
	Measured focus voltage (kV)		—
	CRT markings		—
4.3.13.3	Effect of ultraviolet (UV) radiation on materials		N
	Part, property, retention after test, flammability classification		N
4.3.13.4	Human exposure to ultraviolet (UV) radiation		N
4.3.13.5	Lasers (including laser diodes) and LEDs		P
4.3.13.5.1	Lasers (including laser diodes)		N
	Laser class		—
4.3.13.5.2	Light emitting diodes (LEDs)	Complies with Exempt Group of IEC 62471, see separate test report RSZ151208013-03 issued by BACL.	P
4.3.13.6	Other types		P

4.4	Protection against hazardous moving parts		N
4.4.1	General	No moving parts	N
4.4.2	Protection in operator access areas		N
	Household and home/office document/media shredders		N
4.4.3	Protection in restricted access locations		N
4.4.4	Protection in service access areas		N
4.4.5	Protection against moving fan blades		N
4.4.5.1	General		N
	Not considered to cause pain or injury. a)		N
	Is considered to cause pain, not injury. b)		N
	Considered to cause injury. c)		N
4.4.5.2	Protection for users		N
	Use of symbol or warning		N
4.4.5.3	Protection for service persons		N
	Use of symbol or warning		N

4.5	Thermal requirements		P
4.5.1	General		P
4.5.2	Temperature tests		P
	Normal load condition per Annex L		—
4.5.3	Temperature limits for materials	(see appended table 4.5)	P
4.5.4	Touch temperature limits	(see appended table 4.5)	P
4.5.5	Resistance to abnormal heat		N

EN 60950-1			
Clause	Requirement + Test	Result - Remark	Verdict

4.6	Openings in enclosures		P
4.6.1	Top and side openings	No opening	P
	Dimensions (mm)		—
4.6.2	Bottoms of fire enclosures	No fire enclosure necessary, see 4.7.2	N
	Construction of the bottom, dimensions (mm) ...:		—
4.6.3	Doors or covers in fire enclosures		N
4.6.4	Openings in transportable equipment		N
4.6.4.1	Constructional design measures		N
	Dimensions (mm)		—
4.6.4.2	Evaluation measures for larger openings		N
4.6.4.3	Use of metallized parts		N
4.6.5	Adhesives for constructional purposes		N
	Conditioning temperature (°C), time (weeks).....:		—

4.7	Resistance to fire		N
4.7.1	Reducing the risk of ignition and spread of flame	Method 1 is used.	P
	Method 1, selection and application of components wiring and materials	Equipment is class III equipment, powered from a LPS adapter and battery pack.	P
	Method 2, application of all of simulated fault condition tests	Method 2 is not used for the evaluation of the fire hazard.	N
4.7.2	Conditions for a fire enclosure	Refer below.	P
4.7.2.1	Parts requiring a fire enclosure	Adapter output is LPS and batteries are evaluated to be LPS. All components are mounted on min. V-1 PCB. No fire enclosure required.	N
4.7.2.2	Parts not requiring a fire enclosure	See as above	P
4.7.3	Materials	See as above	P
4.7.3.1	General	PCB rated min.V-1 and enclosure rated min.HB	P
4.7.3.2	Materials for fire enclosures		N
4.7.3.3	Materials for components and other parts outside fire enclosures		N
4.7.3.4	Materials for components and other parts inside fire enclosures		N
4.7.3.5	Materials for air filter assemblies	No air filter assemblies	N
4.7.3.6	Materials used in high-voltage components	No high-voltage components	N

5	Electrical requirements and simulated abnormal conditions		P
----------	--	--	----------

EN 60950-1			
Clause	Requirement + Test	Result - Remark	Verdict
5.1	Touch current and protective conductor current		N
5.1.1	General		N
5.1.2	Configuration of equipment under test (EUT)		N
5.1.2.1	Single connection to an a.c. mains supply		N
5.1.2.2	Redundant multiple connections to an a.c. mains supply		N
5.1.2.3	Simultaneous multiple connections to an a.c. mains supply		N
5.1.3	Test circuit		N
5.1.4	Application of measuring instrument		N
5.1.5	Test procedure		N
5.1.6	Test measurements		N
	Supply voltage (V)		—
	Measured touch current (mA)		—
	Max. allowed touch current (mA)		—
	Measured protective conductor current (mA)		—
	Max. allowed protective conductor current (mA).....		—
5.1.7	Equipment with touch current exceeding 3,5 mA		N
5.1.7.1	General		N
5.1.7.2	Simultaneous multiple connections to the supply		N
5.1.8	Touch currents to telecommunication networks and cable distribution systems and from telecommunication networks		N
5.1.8.1	Limitation of the touch current to a telecommunication network or to a cable distribution system		N
	Supply voltage (V)		—
	Measured touch current (mA)		—
	Max. allowed touch current (mA)		—
5.1.8.2	Summation of touch currents from telecommunication networks		N
	a) EUT with earthed telecommunication ports		N
	b) EUT whose telecommunication ports have no reference to protective earth		N
5.2	Electric strength		N
5.2.1	General		N
5.2.2	Test procedure		N
5.3	Abnormal operating and fault conditions		P

EN 60950-1			
Clause	Requirement + Test	Result - Remark	Verdict
5.3.1	Protection against overload and abnormal operation	Considered	P
5.3.2	Motors	See AnnexB	P
5.3.3	Transformers		N
5.3.4	Functional insulation.....:	Functional insulation complies with the requirements (c).	P
5.3.5	Electromechanical components		N
5.3.6	Audio amplifiers in ITE		N
5.3.7	Simulation of faults	(see appended table 5.3)	P
5.3.8	Unattended equipment	No thermostat, temperature limiter or thermal cut-out.	N
5.3.9	Compliance criteria for abnormal operating and fault conditions	(see appended table 5.3)	P
5.3.9.1	During the tests	No fire or molten metal occurred and no deformation of enclosure during the tests.	P
5.3.9.2	After the tests		P

6	Connection to telecommunication networks		N
6.1	Protection of telecommunication network service persons, and users of other equipment connected to the network, from hazards in the equipment		N
6.1.1	Protection from hazardous voltages		N
6.1.2	Separation of the telecommunication network from earth		N
6.1.2.1	Requirements		N
	Supply voltage (V)		—
	Current in the test circuit (mA)		—
6.1.2.2	Exclusions		N

6.2	Protection of equipment users from overvoltages on telecommunication networks		N
6.2.1	Separation requirements		N
6.2.2	Electric strength test procedure		N
6.2.2.1	Impulse test		N
6.2.2.2	Steady-state test		N
6.2.2.3	Compliance criteria		N

6.3	Protection of the telecommunication wiring system from overheating		N
	Max. output current (A)		—
	Current limiting method		—

7	Connection to cable distribution systems		N
----------	---	--	----------

EN 60950-1			
Clause	Requirement + Test	Result - Remark	Verdict
7.1	General		N
7.2	Protection of cable distribution system service persons, and users of other equipment connected to the system, from hazardous voltages in the equipment		N
7.3	Protection of equipment users from overvoltages on the cable distribution system		N
7.4	Insulation between primary circuits and cable distribution systems		N
7.4.1	General		N
7.4.2	Voltage surge test		N
7.4.3	Impulse test		N

Annex A	Tests for resistance to heat and fire		N
A.1	Flammability test for fire enclosures of movable equipment having a total mass exceeding 18 kg, and of stationary equipment (see 4.7.3.2)		N
A.1.1	Samples.....:		—
	Wall thickness (mm)		—
A.1.2	Conditioning of samples; temperature (°C)		N
A.1.3	Mounting of samples		N
A.1.4	Test flame (see IEC 60695-11-3)		N
	Flame A, B, C or D		—
A.1.5	Test procedure		N
A.1.6	Compliance criteria		N
	Sample 1 burning time (s)		—
	Sample 2 burning time (s)		—
	Sample 3 burning time (s)		—
A.2	Flammability test for fire enclosures of movable equipment having a total mass not exceeding 18 kg, and for material and components located inside fire enclosures (see 4.7.3.2 and 4.7.3.4)		N
A.2.1	Samples, material.....:		—
	Wall thickness (mm)		—
A.2.2	Conditioning of samples; temperature (°C)		N
A.2.3	Mounting of samples		N
A.2.4	Test flame (see IEC 60695-11-4)		N
	Flame A, B or C		—
A.2.5	Test procedure		N
A.2.6	Compliance criteria		N
	Sample 1 burning time (s)		—
	Sample 2 burning time (s)		—

EN 60950-1			
Clause	Requirement + Test	Result - Remark	Verdict
	Sample 3 burning time (s)		—
A.2.7	Alternative test acc. to IEC 60695-11-5, cl. 5 and 9		N
	Sample 1 burning time (s)		—
	Sample 2 burning time (s)		—
	Sample 3 burning time (s)		—
A.3	Hot flaming oil test (see 4.6.2)		N
A.3.1	Mounting of samples		N
A.3.2	Test procedure		N
A.3.3	Compliance criterion		N

Annex B	Motor tests under abnormal conditions (see 4.7.2.2 and 5.3.2)	P
B.1	General requirements	P
	Position	VIBR
	Manufacturer	SHENZHEN HONGZHIFA ELECTRIC CO.,LTD
	Type	HZF1020A-P03L10
	Rated values	3.0V DC
B.2	Test conditions	N
B.3	Maximum temperatures	N
B.4	Running overload test	N
B.5	Locked-rotor overload test	N
	Test duration (days)	—
	Electric strength test: test voltage (V)	—
B.6	Running overload test for d.c. motors in secondary circuits	P
B.6.1	General	P
B.6.2	Test procedure	N
B.6.3	Alternative test procedure	No ignition of wrapping tissue and cheesecloth.
B.6.4	Electric strength test; test voltage (V)	Motor does not exceeds 42.4V peak or 60V d.c.
B.7	Locked-rotor overload test for d.c. motors in secondary circuits	N
B.7.1	General	N
B.7.2	Test procedure	N
B.7.3	Alternative test procedure	No ignition of wrapping tissue and cheesecloth.
B.7.4	Electric strength test; test voltage (V)	Motor does not exceeds 42.4V peak or 60V d.c..
B.8	Test for motors with capacitors	N

EN 60950-1			
Clause	Requirement + Test	Result - Remark	Verdict
B.9	Test for three-phase motors		N
B.10	Test for series motors		N
	Operating voltage (V)		—

Annex C	Transformers (see 1.5.4 and 5.3.3)	N
	Position	—
	Manufacturer	—
	Type	—
	Rated values	—
	Method of protection.....	—
C.1	Overload test	N
C.2	Insulation	N
	Protection from displacement of windings.....	N

Annex D	Measuring instruments for touch-current testes(see 5.1.4)	N
D.1	Measuring instrument	N
D.2	Alternative measuring instrument	N

Annex E	Temperature rise of a winding (see 1.4.13)	N
----------------	---	----------

Annex F	Measurement of clearances and creepage distances (see 2.10 and Annex G)	N
----------------	--	----------

Annex G	Alternative method for determining minimum clearances	N
G.1	Clearances	N
G.1.1	General	N
G.1.2	Summary of the procedure for determining minimum clearances	N
G.2	Determination of mains transient voltage (V)	N
G.2.1	AC mains supply	N
G.2.2	Earthed d.c. mains supplies	N
G.2.3	Unearthed d.c. mains supplies	N
G.2.4	Battery operation	N
G.3	Determination of telecommunication network transient voltage (V)	N
G.4	Determination of required withstand voltage (V)	N
G.4.1	Mains transients and internal repetitive peaks	N
G.4.2	Transients from telecommunication networks	N
G.4.3	Combination of transients	N
G.4.4	Transients from cable distribution systems	N

EN 60950-1			
Clause	Requirement + Test	Result - Remark	Verdict
G.5	Measurement of transient voltages (V)		N
	a) Transients from a mains supply		N
	For an a.c. mains supply		N
	For a d.c. mains supply		N
	b) Transients from a telecommunication network		N
G.6	Determination of minimum clearances		N

Annex H	Ionizing radiation (see 4.3.13)		N
----------------	--	--	----------

Annex J	Table of electrochemical potentials (see 2.6.5.6)		N
	Metal(s) used		—

Annex K	Thermal controls (see 1.5.3 and 5.3.8)		N
K.1	Making and breaking capacity		N
K.2	Thermostat reliability; operating voltage (V)		N
K.3	Thermostat endurance test; operating voltage (V)		N
K.4	Temperature limiter endurance; operating voltage (V)		N
K.5	Thermal cut-out reliability		N
K.6	Stability of operation		N

Annex L	Normal load conditions for same types of electrical business equipment (see 1.2.2.1 and 4.5.2)		P
L.1	Typewriters		N
L.2	Adding machines and cash registers		N
L.3	Erasers		N
L.4	Pencil sharpeners		N
L.5	Duplicators and copy machines		N
L.6	Motor-operated files		N
L.7	Other business equipment	See appended table 1.6.2	P

Annex M	Criteria for telephone ringing signals (see 2.3.1)		N
M.1	Introduction		N
M.2	Method A		N
M.3	Method B		N
M.3.1	Ringing signal		N
M.3.1.1	Frequency (Hz)		—
M.3.1.2	Voltage (V)		—

EN 60950-1			
Clause	Requirement + Test	Result - Remark	Verdict
M.3.1.3	Cadence; time (s), voltage (V)		—
M.3.1.4	Single fault current (mA)		—
M.3.2	Tripping device and monitoring voltage		N
M.3.2.1	Conditions for use of a tripping device or a monitoring voltage		N
M.3.2.2	Tripping device		N
M.3.2.3	Monitoring voltage (V)		N

Annex N	Impulse test generators (see 1.5.7.2, 1.5.7.3, 2.10.3.9, 6.2.2.1, 7.3.2, 7.4.3 and Clause G.5)		N
N.1	ITU-T impulse test generators		N
N.2	IEC 60065 impulse test generator		N

Annex P	Normative references		—
----------------	-----------------------------	--	---

Annex Q	Voltage dependent resistors (VDRs) (see 1.5.9.1)		N
	a) Preferred climatic categories		N
	b) Maximum continuous voltage		N
	c) Pulse current		N
	Body of the VDR Test according to IEC 60695-11-5		N
	Body of the VDR. Flammability class of material (min. V-1)		N

Annex R	Examples of requirements for quality control programmes		N
R.1	Minimum separation distances for unpopulated coated printed boards (see 2.10.6.2)		N
R.2	Reduced clearances (see 2.10.3)		N

Annex S	Procedure for impulse testing (see 6.2.2.3)		N
S.1	Test equipment		N
S.2	Test procedure		N
S.3	Examples of waveforms during impulse testing		N

Annex T	Guidance on protection against ingress of water (see 1.1.2)		N
			—

Annex U	Insulated winding wires for use without interleaved insulation (see 2.10.5.4)		N
			—

EN 60950-1			
Clause	Requirement + Test	Result - Remark	Verdict
Annex V	AC power distribution systems (see 1.6.1)		N
V.1	Introduction		N
V.2	TN power distribution systems		N
Annex W	Summation of touch currents		N
W.1	Touch current from electronic circuits		N
W.1.1	Floating circuits		N
W.1.2	Earthed circuits		N
W.2	Interconnection of several equipments		N
W.2.1	Isolation		N
W.2.2	Common return, isolated from earth		N
W.2.3	Common return, connected to protective earth		N
Annex X	Maximum heating effect in transformer tests (see clause C.1)		N
X.1	Determination of maximum input current		N
X.2	Overload test procedure		N
Annex Y	Ultraviolet light conditioning test (see 4.3.13.3)		N
Y.1	Test apparatus		N
Y.2	Mounting of test samples		N
Y.3	Carbon-arc light-exposure apparatus		N
Y.4	Xenon-arc light exposure apparatus		N
Annex Z	Overvoltage categories (see 2.10.3.2 and Clause G.2)		N
Annex AA	Mandrel test (see 2.10.5.8)		N
Annex BB	Changes in the second edition		—
Annex CC	Evaluation of integrated circuit (IC) current limiters		N
CC.1	General		N
CC.2	Test program 1		—
CC.3	Test program 2		—
CC.4	Test program 3		—
CC.5	Compliance.....		N
Annex DD	Requirements for the mounting means of rack-mounted equipment		N
DD.1	General		N
DD.2	Mechanical strength test, variable N		—

EN 60950-1			
Clause	Requirement + Test	Result - Remark	Verdict
DD.3	Mechanical strength test, 250N, including end stops		—
DD.4	Compliance.....		N

Annex EE	Household and home/office document/media shredders	N
EE.1	General	N
EE.2	Markings and instructions	N
	Use of markings or symbols	N
	Information of user instructions, maintenance and/or servicing instructions	N
EE.3	Inadvertent reactivation test	N
EE.4	Disconnection of power to hazardous moving parts	N
	Use of markings or symbols	N
EE.5	Protection against hazardous moving parts	N
	Test with test finger (Figure 2A)	—
	Test with wedge probe (Figure EE1 and EE2)	—

EN 60950-1			
Clause	Requirement + Test	Result - Remark	Verdict
EN 60950-1:2006+A11:2009+A1:2010+A12:2011+A2:2013 –CENELEC COMMON MODIFICATIONS			
	Clauses, subclauses, notes, tables and figures which are additional to those in IEC60950-1 and it's amendmets are prefixed "Z"		P
Contents (A2:2013)	Add the following annexes: Annex ZA (normative) Normative references to international publications with their corresponding European publications Annex ZB (normative) Special national conditions Annex ZC (informative) A-deviations Annex ZD (informative) IEC and CENELEC code designations for flexible cords		P
General	Delete all the "country" notes in the reference document according to the following list: 1.4.8 Note 2 1.5.1 Note 2 & 3 1.5.7.1 Note 1.5.8 Note 2 1.5.9.4 Note 1.7.2.1 Note 4, 5 & 6 2.2.3 Note 2.2.4 Note 2.3.2 Note 2.3.2.1 Note 2 2.3.4 Note 2 2.6.3.3 Note 2 & 3 2.7.1 Note 2.10.3.2 Note 2 2.10.5.13 Note 3 3.2.1.1 Note 3.2.4 Note 3. 2.5.1 Note 2 4.3.6 Note 1 & 2 4.7 Note 4 4.7.2.2 Note 4.7.3.1 Note 2 5.1.7.1 Note 3 & 4 5.3.7 Note 1 6 Note 2 & 5 6.1.2.1 Note 2 6.1.2.2 Note 6.2.2 Note 6. 2.2.1 Note 2 6.2.2.2 Note 7.1 Note 3 7.2 Note 7.3 Note 1 & 2 G.2.1 Note 2 Annex H Note 2		P
General (A1:2010)	Delete all the "country" notes in the reference document (IEC 60950-1:2005/A1:2010) according to the following list: 1.5.7.1 Note 6.1.2.1 Note 2 6.2.2.1 Note 2 EE.3 Note		P
General (A2:2013)	Delete all the "country" notes in the reference document (IEC 60950-1:2005/A2:2013) according to the following list: 2.7.1 Note * 2.10.3.1 Note 2 6.2.2. Note * Note of secretary: Text of Common Modification remains unchanged.		P
1.1.1 (A1:2010)	Replace the text of NOTE 3 by the following. NOTE 3 The requirements of EN 60065 may also be used to meet safety requirements for multimedia equipment. See IEC Guide 112, Guide on the safety of multimedia equipment. For television sets EN 60065 applies.		P

EN 60950-1			
Clause	Requirement + Test	Result - Remark	Verdict
1.3.Z1	Add the following subclause: 1.3.Z1 Exposure to excessive sound pressure The apparatus shall be so designed and constructed as to present no danger when used for its intended purpose, either in normal operating conditions or under fault conditions, particularly providing protection against exposure to excessive sound pressures from headphones or earphones. NOTE Z1 A new method of measurement is described in EN 50332-1, Sound system equipment: Headphones and earphones associated with portable audio equipment - Maximum sound pressure level measurement methodology and limit considerations - Part 1: General method for "one package equipment", and in EN 50332-2, Sound system equipment: Headphones and earphones associated with portable audio equipment - Maximum sound pressure level measurement methodology and limit considerations - Part 2: Guidelines to associate sets with headphones coming from different manufacturers.		N
(A12:2011)	In EN 60950-1:2006/A12:2011 Delete the addition of 1.3.Z1/EN 60950-1:2006 Delete the definition of 1.2.3.Z1/EN 60950-1:2006/A1:2010		P
1.5.1 (Added info*)	Add the following NOTE: NOTE Z1 The use of certain substances in electrical and electronic equipment is restricted within the EU: see Directive 2002/95/EC. New Directive 2011/65/EU *		P
1.7.2.1 (A1:2010)	In addition, for a PORTABLE SOUND SYSTEM, the instructions shall include a warning that excessive sound pressure from earphones and headphones can cause hearing loss.		N
1.7.2.1 (A12:2011)	In EN 60950-1:2006/A12:2011 Delete NOTE Z1 and the addition for Portable Sound System. Add the following clause and annex to the existing standard and amendments.		N

EN 60950-1			
Clause	Requirement + Test	Result - Remark	Verdict
2.7.1	<p>Replace the subclause as follows:</p> <p>Basic requirements</p> <p>To protect against excessive current, short-circuits and earth faults in PRIMARY CIRCUITS, protective devices shall be included either as integral parts of the equipment or as parts of the building installation, subject to the following, a), b) and c):</p> <p>a) except as detailed in b) and c), protective devices necessary to comply with the requirements of 5.3 shall be included as parts of the equipment;</p> <p>b) for components in series with the mains input to the equipment such as the supply cord, appliance coupler, r.f.i. filter and switch, short-circuit and earth fault protection may be provided by protective devices in the building installation;</p> <p>c) it is permitted for PLUGGABLE EQUIPMENT TYPE B or PERMANENTLY CONNECTED EQUIPMENT, to rely on dedicated overcurrent and short-circuit protection in the building installation, provided that the means of protection, e.g. fuses or circuit breakers, is fully specified in the installation instructions.</p> <p>If reliance is placed on protection in the building installation, the installation instructions shall so state, except that for PLUGGABLE EQUIPMENT TYPE A the building installation shall be regarded as providing protection in accordance with the rating of the wall socket outlet.</p>		N
2.7.2	This subclause has been declared 'void'.		N
3.2.3	Delete the NOTE in Table 3A, and delete also in this table the conduit sizes in parentheses.		N
3.2.5.1	<p>Replace "60245 IEC 53" by "H05 RR-F"; "60227 IEC 52" by "H03 VV-F or H03 VVH2-F"; "60227 IEC 53" by "H05 VV-F or H05 VVH2-F2".</p> <p>In Table 3B, replace the first four lines by the following:</p> <p> Up to and including 6 0,75^{a)} </p> <p> Over 6 up to and including 10 (0,75)^{b)} 1,0 </p> <p> Over 10 up to and including 16 (1,0)^{c)} 1,5 </p> <p>In the conditions applicable to Table 3B delete the words "in some countries" in condition^{a)}.</p> <p>In NOTE 1, applicable to Table 3B, delete the second sentence.</p>		N
3.2.5.1 (A2:2013)	NOTE Z1 The harmonised code designations corresponding to the IEC cord types are given in Annex ZD		N
3.3.4	<p>In Table 3D, delete the fourth line: conductor sizes for 10 to 13 A, and replace with the following:</p> <p> Over 10 up to and including 16 1,5 to 2,5 </p> <p>1,5 to 4 </p> <p>Delete the fifth line: conductor sizes for 13 to 16 A.</p>		N

EN 60950-1			
Clause	Requirement + Test	Result - Remark	Verdict
4.3.13.6 (A1:2010)	Replace the existing NOTE by the following: NOTE Z1 Attention is drawn to: 1999/519/EC: Council Recommendation on the limitation of exposure of the general public to electromagnetic fields 0 Hz to 300 GHz, and 2006/25/EC: Directive on the minimum health and safety requirements regarding the exposure of workers to risks arising from physical agents (artificial optical radiation).		P
	Standards taking into account mentioned Recommendation and Directive which demonstrate compliance with the applicable EU Directive are indicated in the OJEC.		N
Annex H	Replace the last paragraph of this annex by: At any point 10 cm from the surface of the OPERATOR ACCESS AREA, the dose rate shall not exceed 1 μ Sv/h (0,1 mR/h) (see NOTE). Account is taken of the background level. Replace the notes as follows: NOTE These values appear in Directive 96/29/Euratom. Delete NOTE 2.		N
Bibliography	Additional EN standards.		—

ZA	NORMATIVE REFERENCES TO INTERNATIONAL PUBLICATIONS WITH THEIR CORRESPONDING EUROPEAN PUBLICATIONS	—
-----------	--	---

ZB ANNEX (normative) SPECIAL NATIONAL CONDITIONS (EN)			
1.2.4.1	In Denmark , certain types of Class I appliances (see 3.2.1.1) may be provided with a plug not establishing earthing conditions when inserted into Danish socket-outlets.		N
1.2.13.14 (A11:2009)	In Norway and Sweden , for requirements see 1.7.2.1 and 7.3 of this annex.		N
1.5.7.1 (A11:2009)	In Finland , Norway and Sweden , resistors bridging BASIC INSULATION in CLASS I PLUGGABLE EQUIPMENT TYPE A must comply with the requirements in 1.5.7.2.		N
1.5.8	In Norway , due to the IT power system used (see annex V, Figure V.7), capacitors are required to be rated for the applicable line-to-line voltage (230 V).		N
1.5.9.4	In Finland , Norway and Sweden , the third dashed sentence is applicable only to equipment as defined in 6.1.2.2 of this annex.		N

EN 60950-1			
Clause	Requirement + Test	Result - Remark	Verdict
1.7.2.1	<p>In Finland, Norway and Sweden, CLASS I PLUGGABLE EQUIPMENT TYPE A intended for connection to other equipment or a network shall, if safety relies on connection to protective earth or if surge suppressors are connected between the network terminals and accessible parts, have a marking stating that the equipment must be connected to an earthed mains socket-outlet. The marking text in the applicable countries shall be as follows:</p> <p>In Finland: "Laite on liitettävä suojakoskettimilla varustettuun pistorasiaan"</p> <p>In Norway: "Apparatet må tilkoples jordet stikkontakt"</p> <p>In Sweden: "Apparaten skall anslutas till jordat uttag"</p> <p>In Norway and Sweden, the screen of the cable distribution system is normally not earthed at the entrance of the building and there is normally no equipotential bonding system within the building. Therefore the protective earthing of the building installation need to be isolated from the screen of a cable distribution system.</p> <p>It is however accepted to provide the insulation external to the equipment by an adapter or an interconnection cable with galvanic isolator, which may be provided by e.g. a retailer.</p> <p>The user manual shall then have the following or similar information in Norwegian and Swedish language respectively, depending on in what country the equipment is intended to be used in: "Equipment connected to the protective earthing of the building installation through the mains connection or through other equipment with a connection to protective earthing – and to a cable distribution system using coaxial cable, may in some circumstances create a fire hazard. Connection to a cable distribution system has therefore to be provided through a device providing electrical isolation below a certain frequency range (galvanic isolator, see EN 60728-11)."</p> <p>NOTE In Norway, due to regulation for installations of cable distribution systems, and in Sweden, a galvanic isolator shall provide electrical insulation below 5 MHz. The insulation shall withstand a dielectric strength of 1,5 kV r.m.s., 50 Hz or 60 Hz, for 1 min. Translation to Norwegian (the Swedish text will also be accepted in Norway):</p> <p>"Utstyr som er koplet til beskyttelsesjord via nettplugg og/eller via annet jordtilkoplet"</p>		N

EN 60950-1			
Clause	Requirement + Test	Result - Remark	Verdict
	<p>utstyr – og er tilkople et kabel-TV nett, kan forårsake brannfare. For å unngå dette skal det ved tilkopling av utstyret til kabel-TV nettet installeres en galvanisk isolator mellom utstyret og kabel-TV nettet.”</p> <p>Translation to Swedish: ”Utrustning som är kopplad till skyddsjord via jordat vägguttag och/eller via annan utrustning och samtidigt är kopplad till kabel-TV nät kan i vissa fall medföra risk för brand. För att undvika detta skall vid anslutning av utrustningen till kabel-TV nät galvanisk isolator finnas mellan utrustningen och kabel-TV nätet.”</p>		N
1.7.2.1 (A2:2013)	<p>In Denmark, CLASS I PLUGGABLE EQUIPMENT TYPE A intended for connection to other equipment or a network shall, if safety relies on connection to protective earth or if surge suppressors are connected between the network terminals and accessible parts, have a marking stating that the equipment must be connected to an earthed mains socket-outlet.</p> <p>The marking text in Denmark shall be as follows: In Denmark: “Apparatets stikprop skal tilsluttes en stikkontakt med jord, som giver forbindelse til stikproppens jord.”</p>		N
1.7.5 (A11:2009)	<p>In Denmark, socket-outlets for providing power to other equipment shall be in accordance with the Heavy Current Regulations, Section 107-2-D1, Standard Sheet DK 1-3a, DK 1-5a or DK 1-7a, when used on Class I equipment. For STATIONARY EQUIPMENT the socket-outlet shall be in accordance with Standard Sheet DK 1-1b or DK 1-5a.</p> <p>For CLASS II EQUIPMENT the socket outlet shall be in accordance with Standard Sheet DKA 1-4a.</p>		N
1.7.5 (A2:2013)	<p>In Denmark, socket-outlets for providing power to other equipment shall be in accordance with the DS 60884-2-D1:2011.</p> <p>For class I equipment the following Standard Sheets are applicable: DK 1-3a, DK 1-1c, DK 1-1d, DK 1-5a or DK 1-7a, with the exception for STATIONARY EQUIPMENT where the socket-outlets shall be in accordance with Standard Sheet DK 1-1b, DK 1-1c, DK 1-1d or DK 1-5a.</p> <p>Socket outlets intended for providing power to Class II apparatus with a rated current of 2,5 A shall be in accordance with DS 60884-2-D1 standard sheet DKA 1-4a. Other current rating socket outlets shall be in compliance with by DS 60884-2-D1 Standard Sheet DKA 1-3a or DKA 1-3b.</p> <p>Justification the Heavy Current Regulations, 6c</p>		N

EN 60950-1			
Clause	Requirement + Test	Result - Remark	Verdict
2.2.4	In Norway , for requirements see 1.7.2.1, 6.1.2.1 and 6.1.2.2 of this annex.		N
2.3.2	In Finland, Norway and Sweden there are additional requirements for the insulation. See 6.1.2.1 and 6.1.2.2 of this annex.		N
2.3.4	In Norway , for requirements see 1.7.2.1, 6.1.2.1 and 6.1.2.2 of this annex.		N
2.6.3.3	In the United Kingdom , the current rating of the circuit shall be taken as 13 A, not 16 A.		N
2.7.1	In the United Kingdom , to protect against excessive currents and short-circuits in the PRIMARY CIRCUIT of DIRECT PLUG-IN EQUIPMENT, tests according to 5.3 shall be conducted, using an external protective device rated 30 A or 32 A. If these tests fail, suitable protective devices shall be included as integral parts of the DIRECT PLUG-IN EQUIPMENT, so that the requirements of 5.3 are met.		N
2.10.5.13	In Finland, Norway and Sweden , there are additional requirements for the insulation, see 6.1.2.1 and 6.1.2.2 of this annex.		N
3.2.1.1	<p>In Switzerland, supply cords of equipment having a RATED CURRENT not exceeding 10 A shall be provided with a plug complying with SEV 1011 or IEC 60884-1 and one of the following dimension sheets:</p> <p>SEV 6532-2.1991 Plug Type 15 3P+N+PE 250/400 V, 10 A</p> <p>SEV 6533-2.1991 Plug Type 11 L+N 250 V, 10 A</p> <p>SEV 6534-2.1991 Plug Type 12 L+N+PE 250 V, 10 A</p> <p>In general, EN 60309 applies for plugs for currents exceeding 10 A. However, a 16 A plug and socket-outlet system is being introduced in Switzerland, the plugs of which are according to the following dimension sheets, published in February 1998:</p> <p>SEV 5932-2.1998 Plug Type 25 3L+N+PE 230/400 V, 16 A</p> <p>SEV 5933-2.1998 Plug Type 21 L+N 250 V, 16 A</p> <p>SEV 5934-2.1998 Plug Type 23 L+N+PE 250 V, 16 A</p>		N

EN 60950-1			
Clause	Requirement + Test	Result - Remark	Verdict
3.2.1.1	<p>In Denmark, supply cords of single-phase equipment having a rated current not exceeding 13 A shall be provided with a plug according to the Heavy Current Regulations, Section 107-2-D1.</p> <p>CLASS I EQUIPMENT provided with socket-outlets with earth contacts or which are intended to be used in locations where protection against indirect contact is required according to the wiring rules shall be provided with a plug in accordance with standard sheet DK 2-1a or DK 2-5a.</p> <p>If poly-phase equipment and single-phase equipment having a RATED CURRENT exceeding 13 A is provided with a supply cord with a plug, this plug shall be in accordance with the Heavy Current Regulations, Section 107-2-D1 or EN 60309-2.</p>		N
3.2.1.1 (A2:2013)	<p>In Denmark, supply cords of single-phase equipment having a rated current not exceeding 13 A shall be provided with a plug according to DS 60884-2-D1.</p> <p>CLASS I EQUIPMENT provided with socket-outlets with earth contacts or which are intended to be used in locations where protection against indirect contact is required according to the wiring rules shall be provided with a plug in accordance with standard sheet DK 2-1a or DK 2-5a.</p> <p>If a single-phase equipment having a RATED CURRENT exceeding 13 A or if a poly-phase equipment is provided with a supply cord with a plug, this plug shall be in accordance with the standard sheets DK 6-1a in DS 60884-2-D1 or EN 60309-2.</p> <p>Justification the Heavy Current Regulations, 6c</p>		N
3.2.1.1	<p>In Spain, supply cords of single-phase equipment having a rated current not exceeding 10 A shall be provided with a plug according to UNE 20315:1994.</p> <p>Supply cords of single-phase equipment having a rated current not exceeding 2,5 A shall be provided with a plug according to UNE-EN 50075:1993.</p> <p>CLASS I EQUIPMENT provided with socket-outlets with earth contacts or which are intended to be used in locations where protection against indirect contact is required according to the wiring rules, shall be provided with a plug in accordance with standard UNE 20315:1994.</p> <p>If poly-phase equipment is provided with a supply cord with a plug, this plug shall be in accordance with UNE-EN 60309-2.</p>		N

EN 60950-1			
Clause	Requirement + Test	Result - Remark	Verdict
3.2.1.1	In the United Kingdom , apparatus which is fitted with a flexible cable or cord and is designed to be connected to a mains socket conforming to BS 1363 by means of that flexible cable or cord and plug, shall be fitted with a 'standard plug' in accordance with Statutory Instrument 1768:1994 - The Plugs and Sockets etc. (Safety) Regulations 1994, unless exempted by those regulations. NOTE 'Standard plug' is defined in SI 1768:1994 and essentially means an approved plug conforming to BS 1363 or an approved conversion plug.		N
3.2.1.1	In Ireland , apparatus which is fitted with a flexible cable or cord and is designed to be connected to a mains socket conforming to I.S. 411 by means of that flexible cable or cord and plug, shall be fitted with a 13 A plug in accordance with Statutory Instrument 525:1997 - National Standards Authority of Ireland (section 28) (13 A Plugs and Conversion Adaptors for Domestic Use) Regulations 1997.		N
3.2.4	In Switzerland , for requirements see 3.2.1.1 of this annex.		N
3.2.5.1	In the United Kingdom , a power supply cord with conductor of 1,25 mm ² is allowed for equipment with a rated current over 10 A and up to and including 13 A.		N
3.3.4	In the United Kingdom , the range of conductor sizes of flexible cords to be accepted by terminals for equipment with a RATED CURRENT of over 10 A up to and including 13 A is: • 1,25 mm ² to 1,5 mm ² nominal cross-sectional area.		N
4.3.6	In the United Kingdom , the torque test is performed using a socket outlet complying with BS 1363 part 1:1995, including Amendment 1:1997 and Amendment 2:2003 and the plug part of DIRECT PLUG-IN EQUIPMENT shall be assessed to BS 1363: Part 1, 12.1, 12.2, 12.3, 12.9, 12.11, 12.12, 12.13, 12.16 and 12.17, except that the test of 12.17 is performed at not less than 125 °C. Where the metal earth pin is replaced by an Insulated Shutter Opening Device (ISOD), the requirements of clauses 22.2 and 23 also apply.		N
4.3.6	In Ireland , DIRECT PLUG-IN EQUIPMENT is known as plug similar devices. Such devices shall comply with Statutory Instrument 526:1997 - National Standards Authority of Ireland (Section 28) (Electrical plugs, plug similar devices and sockets for domestic use) Regulations, 1997.		N

EN 60950-1			
Clause	Requirement + Test	Result - Remark	Verdict
5.1.7.1	<p>In Finland, Norway and Sweden TOUCH CURRENT measurement results exceeding 3,5 mA r.m.s. are permitted only for the following equipment:</p> <ul style="list-style-type: none"> • STATIONARY PLUGGABLE EQUIPMENT TYPE A that <ul style="list-style-type: none"> ○ is intended to be used in a RESTRICTED ACCESS LOCATION where equipotential bonding has been applied, for example, in a telecommunication centre; and ○ has provision for a permanently connected PROTECTIVE EARTHING CONDUCTOR; and ○ is provided with instructions for the installation of that conductor by a SERVICE PERSON; • STATIONARY PLUGGABLE EQUIPMENT TYPE B; • STATIONARY PERMANENTLY CONNECTED EQUIPMENT. 		N

EN 60950-1			
Clause	Requirement + Test	Result - Remark	Verdict
6.1.2.1 (A1:2010)	<p>In Finland, Norway and Sweden, add the following text between the first and second paragraph of the compliance clause:</p> <p>If this insulation is solid, including insulation forming part of a component, it shall at least consist of either</p> <ul style="list-style-type: none"> - two layers of thin sheet material, each of which shall pass the electric strength test below, or - one layer having a distance through insulation of at least 0,4 mm, which shall pass the electric strength test below. <p>Alternatively for components, there is no distance through insulation requirements for the insulation consisting of an insulating compound completely filling the casing, so that CLEARANCES and CREEPAGE DISTANCES do not exist, if the component passes the electric strength test in accordance with the compliance clause below and in addition</p> <ul style="list-style-type: none"> - passes the tests and inspection criteria of 2.10.11 with an electric strength test of 1,5 kV multiplied by 1,6 (the electric strength test of 2.10.10 shall be performed using 1,5 kV), and - is subject to ROUTINE TESTING for electric strength during manufacturing, using a test voltage of 1,5 kV. <p>It is permitted to bridge this insulation with an optocoupler complying with 2.10.5.4 b).</p> <p>It is permitted to bridge this insulation with a capacitor complying with EN 60384-14:2005, subclass Y2.</p> <p>A capacitor classified Y3 according to EN 60384-14:2005, may bridge this insulation under the following conditions:</p> <ul style="list-style-type: none"> - the insulation requirements are satisfied by having a capacitor classified Y3 as defined by EN 60384-14, which in addition to the Y3 testing, is tested with an impulse test of 2,5 kV defined in EN 60950-1:2006, 6.2.2.1; - the additional testing shall be performed on all the test specimens as described in EN 60384-14; - the impulse test of 2,5 kV is to be performed before the endurance test in EN 60384-14, in the sequence of tests as described in EN 60384-14. 		N

EN 60950-1			
Clause	Requirement + Test	Result - Remark	Verdict
6.1.2.2	In Finland, Norway and Sweden , the exclusions are applicable for PERMANENTLY CONNECTED EQUIPMENT, PLUGGABLE EQUIPMENT TYPE B and equipment intended to be used in a RESTRICTED ACCESS LOCATION where equipotential bonding has been applied, e.g. in a telecommunication centre, and which has provision for a permanently connected PROTECTIVE EARTHING CONDUCTOR and is provided with instructions for the installation of that conductor by a SERVICE PERSON.		N
7.2	In Finland, Norway and Sweden , for requirements see 6.1.2.1 and 6.1.2.2 of this annex. The term TELECOMMUNICATION NETWORK in 6.1.2 being replaced by the term CABLE DISTRIBUTION SYSTEM.		N
7.3 (A11:2009)	In Norway and Sweden , for requirements see 1.2.13.14 and 1.7.2.1 of this annex.		N

Annex ZC (informative) A-deviations			
1.5.1	Switzerland (Ordinance on environmentally hazardous substances SR 814.081, Annex 1.7, Mercury - Annex 1.7 of SR 814.81 applies for mercury.) Add the following: NOTE In Switzerland, switches containing mercury such as thermostats, relays and level controllers are not allowed.		N
1.7.2.1	Germany (Gesetz über technische Arbeitsmittel und Verbraucherprodukte (Geräte- und Produktsicherheitsgesetz – GPSG) [Law on technical labour equipment and consumer products], of 6th January 2004, Section 2, Article 4, Clause (4), Item 2). If for the assurance of safety and health certain rules during use, amending or maintenance of a technical labour equipment or readymade consumer product are to be followed, a manual in German language has to be delivered when placing the product on the market. Of this requirement, rules for use even only by SERVICE PERSONS are not exempted.		N
1.7.13	Switzerland (Ordinance on chemical hazardous risk reduction SR 814.81, Annex 2.15 Batteries) Annex 2.15 of SR 814.81 applies for batteries.		N
Zx. Protection against excessive sound pressure from personal music players			

EN 60950-1			
Clause	Requirement + Test	Result - Remark	Verdict
	<p>Zx.1 General This sub-clause specifies requirements for protection against excessive sound pressure from personal music players that are closely coupled to the ear. It also specifies requirements for earphones and headphones intended for use with personal music players.</p> <p>A personal music player is a portable equipment for personal use, that:</p> <ul style="list-style-type: none"> – is designed to allow the user to listen to recorded or broadcast sound or video; and – primarily uses headphones or earphones that can be worn in or on or around the ears; and – allows the user to walk around while in use. <p>NOTE 1 Examples are hand-held or body-worn portable CD players, MP3 audio players, mobile phones with MP3 type features, PDA"s or similar equipment.</p> <p>A personal music player and earphones or headphones intended to be used with personal music players shall comply with the requirements of this sub-clause.</p> <p>The requirements in this sub-clause are valid for music or video mode only. The requirements do not apply:</p> <ul style="list-style-type: none"> – while the personal music player is connected to an external amplifier; or – while the headphones or earphones are not used. <p>NOTE 2 An external amplifier is an amplifier which is not part of the personal music player or the listening device, but which is intended to play the music as a standalone music player.</p> <p>The requirements do not apply to:</p> <ul style="list-style-type: none"> – hearing aid equipment and professional equipment; <p>NOTE 3 Professional equipment is equipment sold through special sales channels. All products sold through normal electronics stores are considered not to be professional equipment.</p> <ul style="list-style-type: none"> – analogue personal music players (personal music players without any kind of digital processing of the sound signal) that are brought to the market before the end of 2015. <p>NOTE 4 This exemption has been allowed because this technology is falling out of use and it is expected that within a few years it will no longer exist. This exemption will not be extended to other technologies.</p> <p>For equipment which is clearly designed or intended for use by young children, the limits of EN 71-1 apply.</p>	<p>The appliance includes an analogue electrical output socket and listening device. So the requirements for protection against excessive sound pressure from personal music players are considered.</p>	<p>P</p>

EN 60950-1			
Clause	Requirement + Test	Result - Remark	Verdict
	<p>Zx.2 Equipment requirements</p> <p>No safety provision is required for equipment that complies with the following:</p> <ul style="list-style-type: none"> – equipment provided as a package (personal music player with its listening device), where the acoustic output $L_{Aeq,T} \leq 85$ dBA measured while playing the fixed “programme simulation noise” as described in EN 50332-1; and – a personal music player provided with an analogue electrical output socket for a listening device, where the electrical output is ≤ 27 mV measured as described in EN 50332-2, while playing the fixed “programme simulation noise” as described in EN 50332-1. <p>NOTE 1 Wherever the term acoustic output is used in this clause, the 30 s A-weighted equivalent sound pressure level $L_{Aeq,T}$ is meant. See also Zx.5 and Annex Zx.</p> <p>All other equipment shall:</p> <ul style="list-style-type: none"> a) protect the user from unintentional acoustic outputs exceeding those mentioned above; and b) have a standard acoustic output level not exceeding those mentioned above, and automatically return to an output level not exceeding those mentioned above when the power is switched off; and c) provide a means to actively inform the user of the increased sound pressure when the equipment is operated with an acoustic output exceeding those mentioned above. Any means used shall be acknowledged by the user before activating a mode of operation which allows for an acoustic output exceeding those mentioned above. The acknowledgement does not need to be repeated more than once every 20 h of cumulative listening time; and <p>NOTE 2 Examples of means include visual or audible signals. Action from the user is always required.</p> <p>NOTE 3 The 20 h listening time is the accumulative listening time, independent how often and how long the personal music player has been switched off.</p> <ul style="list-style-type: none"> d) have a warning as specified in Zx.3; and e) not exceed the following: <ul style="list-style-type: none"> 1) equipment provided as a package (player with its listening device), the acoustic output shall be ≤ 100 dBA measured while playing the fixed “programme simulation noise” described in EN 50332-1; and 	<p>Software version: Brondi_530_4G_HD_V3.0</p> <p>For music player mode: Max. acoustic output: L-channel: 97.0 dBA R-channel: 97.0 dBA</p> <p>Max. electrical output: L-channel: 117 mV R-channel: 117 mV</p> <p>The output level can automatically return to no more than 27mV and 85dBA when the power was switched off;</p> <p>And when increased the volume, the warning appear, the output level no more than 27mV and 85dBA. It can't increased the volume before activating by user. The acknowledgement repeated before 20 h of cumulative listening time.</p>	P

EN 60950-1			
Clause	Requirement + Test	Result - Remark	Verdict
	<p>2) a personal music player provided with an analogue electrical output socket for a listening device, the electrical output shall be ≤ 150 mV measured as described in EN 50332-2, while playing the fixed "programme simulation noise" described in EN 50332-1. For music where the average sound pressure (long term $L_{Aeq,T}$) measured over the duration of the song is lower than the average produced by the programme simulation noise, the warning does not need to be given as long as the average sound pressure of the song is below the basic limit of 85 dBA. In this case T becomes the duration of the song.</p> <p>NOTE 4 Classical music typically has an average sound pressure (long term $L_{Aeq,T}$) which is much lower than the average programme simulation noise. Therefore, if the player is capable to analyse the song and compare it with the programme simulation noise, the warning does not need to be given as long as the average sound pressure of the song is below the basic limit of 85 dBA. For example, if the player is set with the programme simulation noise to 85 dBA, but the average music level of the song is only 65 dBA, there is no need to give a warning or ask an acknowledgement as long as the average sound level of the song is not above the basic limit of 85 dBA.</p>		P
	<p>Zx.3 Warning The warning shall be placed on the equipment, or on the packaging, or in the instruction manual and shall consist of the following:</p> <ul style="list-style-type: none"> – the symbol of Figure 1 with a minimum height of 5 mm; and – the following wording, or similar: "To prevent possible hearing damage, do not listen at high volume levels for long periods." <div style="text-align: center;">  </div> <p>Figure 1 – Warning label (IEC 60417-6044) Alternatively, the entire warning may be given through the equipment display during use, when the user is asked to acknowledge activation of the higher level.</p>	The entire warning is placed on the equipment and stated in the instruction manual.	N
	<p>Zx.4 Requirements for listening devices (headphones and earphones)</p>		P
	<p>Zx.4.1 Wired listening devices with analogue input With 94 dBA sound pressure output $L_{Aeq,T}$, the input voltage of the fixed "programme simulation noise" described in EN 50332-2 shall be ≥ 75 mV. This requirement is applicable in any mode where the headphones can operate (active or passive), including any available setting (for example built-in volume level control). NOTE The values of 94 dBA – 75 mV correspond with 85dBA – 27 mV and 100 dBA – 150 mV.</p>	L-channel: 100 mV R-channel: 100 mV	P

EN 60950-1			
Clause	Requirement + Test	Result - Remark	Verdict
	<p>Zx.4.2 Wired listening devices with digital input With any playing device playing the fixed “programme simulation noise” described in EN 50332-1 (and respecting the digital interface standards, where a digital interface standard exists that specifies the equivalent acoustic level), the acoustic output $L_{Aeq,T}$ of the listening device shall be ≤ 100 dBA.</p> <p>This requirement is applicable in any mode where the headphones can operate, including any available setting (for example built-in volume level control, additional sound feature like equalization, etc.).</p> <p>NOTE An example of a wired listening device with digital input is a USB headphone.</p>		N
	<p>Zx.4.3 Wireless listening devices In wireless mode:</p> <ul style="list-style-type: none"> – with any playing and transmitting device playing the fixed programme simulation noise described in EN 50332-1; and – respecting the wireless transmission standards, where an air interface standard exists that specifies the equivalent acoustic level; and – with volume and sound settings in the listening device (for example built-in volume level control, additional sound feature like equalization, etc.) set to the combination of positions that maximize the measured acoustic output for the abovementioned programme simulation noise, the acoustic output $L_{Aeq,T}$ of the listening device shall be ≤ 100 dBA. <p>NOTE An example of a wireless listening device is a Bluetooth headphone.</p>		N
	<p>Zx.5 Measurement methods Measurements shall be made in accordance with EN 50332-1 or EN 50332-2 as applicable. Unless stated otherwise, the time interval T shall be 30 s.</p> <p>NOTE Test method for wireless equipment provided without listening device should be defined.</p>		P

EN 60950-1			
Clause	Requirement + Test	Result - Remark	Verdict

**Annex ZD
(informative)**

IEC and CENELEC code designations for flexible cords

Type of flexible cord	Code designations	
	IEC	CENELEC
PVC insulated cords		
Flat twin tinsel cord	60227 IEC 41	H03VH-Y
Light polyvinyl chloride sheathed flexible cord	60227 IEC 52	H03VV-F H03VVH2-F
Ordinary polyvinyl chloride sheathed flexible cord	60277 IEC 53	H05VV-F H05VVH2-F
Rubber insulated cords		
Braided cord	60245 IEC 51	H03RT-F
Ordinary tough rubber sheathed flexible cord	60245 IEC 53	H05RR-F
Ordinary polychloroprene sheathed flexible cord	60245 IEC 57	H05RN-F
Heavy polychloroprene sheathed flexible cord	60245 IEC 66	H07RN-F
Cords having high flexibility		
Rubber insulated and sheathed cord	60245 IEC 86	H03RR-H
Rubber insulated, crosslinked PVC sheathed cord	60245 IEC 87	H03RV4-H
Crosslinked PVC insulated and sheathed cord	60245 IEC 88	H03V4V4-H

EN 60950-1			
Clause	Requirement + Test	Result - Remark	Verdict

1.5.1	TABLE: List of critical components					P
Object/part No.	Manufacturer/ trademark	Type/model	Technical data	Standard (Edition / year)	Mark(s) of conformity ¹⁾	
PCB	Various	Various	Min V-1,105°C	UL94 UL796	UL	
Enclosure material	Various	Various	Min HB,60°C	UL94 UL746	UL	
Power Adapter	Shenzhen JINGRICHANG Electronic Technology Co., Ltd	JT108-0501000	Rated Input: 100-240V~ 50/60Hz 0.2A Output: 5.0 Vdc 1000 mA(L.P.S.)	EN 60950-1: 2006 + A11: 2009 + A1: 2010+A12: 2011+A2:2013	Tested by SHENZHEN POCE TECHNOLOGY CO., LTD. Report No.: POCE16012008 CRS	
Li-ion Battery	Shenzhen Nalon Battery Co., Ltd.	Smartphone	3.8V 2200mAh Max. charging current: 1100mA Max. discharging current: 2200mA	IEC 62133:2012 (Second Edition)	Tested by Attestation of Global Compliance (Shenzhen) Co., Ltd Report No.: A001B20151230 026	
Motor	SHENZHEN HONGZHIFA ELECTRIC CO.,LTD	HZF1020A-P03L10	DC 3.0V	EN 60950-1:2006+A11:2009+A1:2010+A12:2011+A2:2013	Tested with equipment	
LCD	LEAD COMMUNICATIONS LTD.	D50PRS98C 4GQ	2.8V	EN 60950-1:2006+A11:2009+A1:2010+A12:2011+A2:2013	Tested with equipment	
Speaker	Various	Various	8 ± 15% ohms	EN 60950-1:2006+A11:2009+A1:2010+A12:2011+A2:2013	Tested with equipment	
Earphone	Dongguan Chuang Shuo Electronics Co., Ltd.	CS15050-Ashna	IMPEDANCE of speaker: 32 ± 15%	EN 60950-1:2006+A11:2009+A1:2010+A12:2011+A2:2013	Tested with equipment	
Torch LED	Eoec-tech Photoelectric Technology (Dalian) Co., Ltd.	NLW2016	2.9-3.3Vdc,350 mA Exempt Group For LED Classification	IEC 62471:2006(First Edition)	Tested with equipment	

1) An asterisk indicates a mark which assures the agreed level of surveillance

Supplementary information:

EN 60950-1			
Clause	Requirement + Test	Result - Remark	Verdict

1.5.1	TABLE: Opto Electronic Devices	N
Manufacturer:		
Type:		
Separately tested:		
Bridging insulation.....:		
External creepage distance:		
Internal creepage distance.....:		
Distance through insulation.....:		
Tested under the following conditions:		
Input:		
Output:		
Supplementary information:		

1.6.2	TABLE: Electrical data (in normal conditions)							P
Input			output			Fuse #	Ifuse (A)	Condition/status
U (V)	I (mA)	Irated (mA)	U (V)	I (mA)	Irated (mA)	I (A)	Irated (A)	
Normal operation 1: (Operating with empty battery by charger-charging)								
90V/50Hz	116.3	200	5.26	881	1000	---	---	Max. operating condition and charging with empty battery by charger.
100V/50Hz	104.1	200	5.26	881	1000	---	---	Max. operating condition and charging with empty battery by charger.
240V/50Hz	50.7	200	5.26	881	1000	---	---	Max. operating condition and charging with empty battery by charger.
254V/50Hz	48.2	200	5.26	881	1000	---	---	Max. operating condition and charging with empty battery by charger.
Normal operation 2: (Operating with full battery only-discharging)								
---	---	---	4.2	500	---	---	---	Max. operating condition and discharging with full battery
Supplementary information:								

2.1.1.5 c)1)	TABLE: max. V, A, VA test				P
Voltage (rated) (V)	Current (rated) (A)	Voltage (max.) (V)	Current (max.) (A)	VA (max.) (VA)	
3.8	---	4.2	2.9	9.8	
Supplementary information:					

EN 60950-1			
Clause	Requirement + Test	Result - Remark	Verdict

2.1.1.5 c)2)	TABLE: stored energy		N
Capacitance C (μ F)	Voltage U (V)	Energy E (J)	
Supplementary information:			

2.2	TABLE: evaluation of voltage limiting components in SELV circuits		N
Component (measured between)	max. voltage (V) (normal operation)		Voltage Limiting Components
	V peak	V d.c.	
Fault test performed on voltage limiting components	Voltage measured (V) in SELV circuits (V peak or V d.c.)		
Supplementary information:			

2.4.2	TABLE: limited current circuit measurement			N
Location	Voltage (V)	Current (mA)	Freq. (KHz)	Limit (mA)
Supplementary information:				

2.5	TABLE: limited power sources			P
Circuit output tested: Battery output				
Measured Uoc (V) with all load circuits disconnected : Uoc:4.2 V				
	Isc (A)		VA	
	Meas.	Limit	Meas.	Limit
Normal operation	2.9	8	9.8	100
U2 pin(7-8) S-C on the battery protection circuit	3.2	8	10.7	100
U2 pin(1-2) S-C on the battery protection circuit	3.5	8	11.5	100
Supplementary information:				
Sc=Short circuit				

EN 60950-1			
Clause	Requirement + Test	Result - Remark	Verdict

2.10.2	Table: working voltage measurement			N
Location	Peak voltage (V)	RMS voltage (V)	Comments	
Supplementary information:				

2.10.3 and 2.10.4	TABLE: Clearance and creepage distance measurements						N
Clearance (cl) and creepage distance (cr) at/of/between:	U peak (V)	U r.m.s. (V)	Required cl (mm)	cl (mm)	Required cr (mm)	cr (mm)	
Supplementary information:							

2.10.5	TABLE: Distance through insulation measurements						N
Distance through insulation (DTI) at/of:	U peak (V)	U rms (V)	Test voltage (V)	Required DTI (mm)	DTI (mm)		
Supplementary information:							

4.3.8	TABLE: Batteries									P
The tests of 4.3.8 are applicable only when appropriate battery data is not available										P
Is it possible to install the battery in a reverse polarity position?										P
	Non-rechargeable batteries			Rechargeable batteries						
	Discharging		Un-intentional charging	Charging		Discharging		Reversed charging		
	Meas. current	Manuf. Specs.		Meas. current	Manuf. Specs.	Meas. current	Manuf. Specs.	Meas. current	Manuf. Specs.	
Max. current during normal condition	-	-	-	580mA	1100mA	5 00mA	2200mA	-	-	
Max. current during fault condition	-	-	-	600mA	1100mA	530mA	2200mA	-	-	
Test results:										Verdict

EN 60950-1			
Clause	Requirement + Test	Result - Remark	Verdict
	- Chemical leaks	No	P
	- Explosion of the battery	No	P
	- Emission of flame or expulsion of molten metal	No	P
	- Electric strength tests of equipment after completion of tests	Not applied	N
Supplementary information:			

4.3.8	TABLE: Batteries	See the table 1.5.1	P
Battery category.....: —			
Manufacturer.....: —			
Type / model.....: —			
Voltage.....: —			
Capacity.....: —			
Tested and Certified by (incl. Ref. No.): —			
Circuit protection diagram:		See the appendix C	
MARKINGS AND INSTRUCTIONS (1.7.13)			
Location of replaceable battery		In an operator access area	
Language(s).....: —		English	
Close to the battery.....: —		-	
In the servicing instructions.....: —		-	
In the operating instructions.....: —		RISK OF EXPLOSION IF BATTERY IS REPLACED BY AN INCORRECT TYPE. DISPOSE OF USED BATTERIES ACCORDING TO THE INSTRUCTION	

4.5	TABLE: Thermal requirements					P
	Supply voltage (V).....: —	A		B		—
	Ambient Tmin (°C).....: —	24.0	--	24.0	--	—
	Ambient Tmax (°C).....: —	24.3	Shift to Tma	24.3	Shift to Tma	—
	Maximum measured temperature T of part/at:	T (°C)				Allowed Tmax (°C)
	Ambient	24.3	40.0	24.3	40.0	--
	Screen	31.3	47.0	30.1	45.8	60
	Battery surface	31.4	47.1	30.2	45.9	70
	Enclosure	33.8	49.5	33.2	48.9	60
	PCB	38.5	54.2	36.8	52.5	105
Supplementary information:						
1. Tma is 40°C;						
2. A- Operating with empty battery by charger-charging						
3. B- Operating with full battery only-discharging.						

EN 60950-1			
Clause	Requirement + Test	Result - Remark	Verdict

Temperature T of winding:	t ₁ (°C)	R ₁ (Ω)	t ₂ (°C)	R ₂ (Ω)	T (°C)	Allowed T _{max} (°C)	Insulation class
Supplementary information:							

4.5.5	TABLE: Ball pressure test of thermoplastic parts			N
	Allowed impression diameter (mm)	≤ 2 mm		—
Part	Test temperature (°C)		Impression diameter (mm)	
Supplementary information:				

4.7	TABLE: Resistance to fire					P
Part	Manufacturer of material	Type of material	Thickness (mm)	Flammability class	Evidence	
Supplementary information:						
See table 1.5.1						

5.1	TABLE: touch current measurement			N
Measured between:	Measured (mA)	Limit (mA)	Comments/conditions	
Supplementary information:				

5.2	TABLE: Electric strength tests, impulse tests and voltage surge tests			N
Test voltage applied between:	Voltage shape (AC, DC, impulse, surge)	Test voltage (V)	Breakdown Yes / No	
Supplementary information:				

5.3	TABLE: Fault condition tests		P
	Ambient temperature (°C)	24.2	—

EN 60950-1						
Clause	Requirement + Test				Result - Remark	Verdict
	Power source for EUT: Manufacturer, model/type, output rating				See appended table 1.5.1	—
Component No.	Fault	Supply voltage (V)	Test time	Fuse #	Current (A)	Observation
Speaker	S-C	5.0VDC	1h	---	---	Speaker shut down immediately. NCD, NFG,NHT. Recoverable.
U2pin(1,2) in battery protection circuit	S-C	4.2VDC	7h	---	---	Excessive discharging with fully charged battery and continued for 7hrs, The battery is undamaged, no explosion, no chemical leaks, no emission of flame or expulsion of molten metal.
U2pin(7,8) in battery protection circuit	S-C	5.0VDC	7h	---	---	Charging the fully charged battery and continued for 7hrs. The battery is undamaged, no explosion, no chemical leaks, no emission of flame or expulsion of molten metal.
Battery Pack output	S-C	4.2VDC	10min	---	---	The battery is undamaged, no explosion, no chemical leaks, no emission of flame or expulsion of molten metal.
Battery pack	Overcharge	5.0VDC	7h	---	---	The battery is undamaged, no explosion, no chemical leaks, no emission of flame or expulsion of molten metal.
Motor	Overload	3.0VDC	7h	—	—	NCD, NFG,NHT. Recoverable.
Motor	Locked rotor	3.0VDC	7h	—	—	NCD, NFG,NHT. Recoverable.
Supplementary information:						
NHT: No High Temperature; NCD: No Component Damage; NFG no flammability gas; S-C:Short circuit						

C.2	TABLE: transformers						N
Loc.	Tested insulation	Working voltage peak / V (2.10.2)	Working voltage rms / V (2.10.2)	Required electric strength (5.2)	Required clearance / mm (2.10.3)	Required creepage distance / mm(2.10.4)	Required distance thr. insul. (2.10.5)
Loc.	Tested insulation			Test voltage/ V	Measured clearance / mm	Measured creepage dist./ mm	Measured distance thr. insul. / mm; number of layers
Supplementary information:							

Appendix A EUT PHOTOS

A.1 EUT- Whole view



A.2 EUT- Top view of main unit



A.3 EUT- Bottom view of main unit



A.4 EUT- Uncover view-1 of main unit



A.5 EUT- Uncover view-2 of main unit
Version 1.1 (2013-12-24)

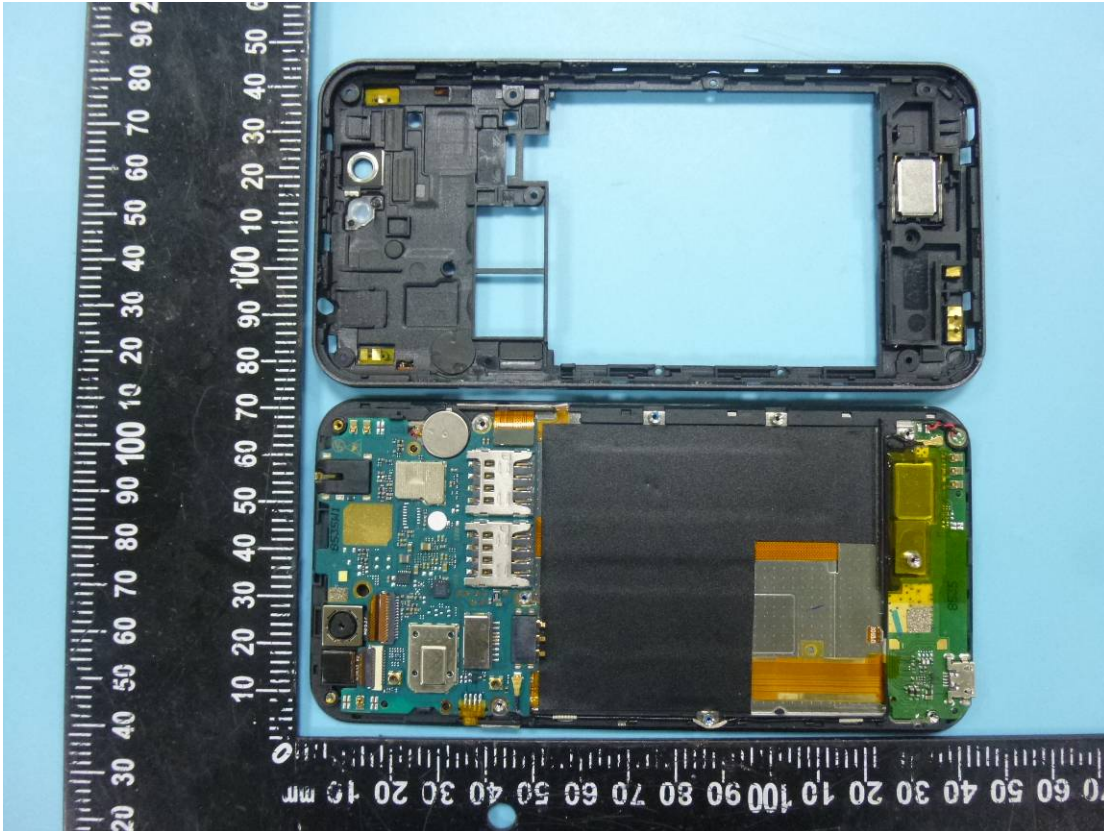

A.6 EUT- Top view of mainboard PCB

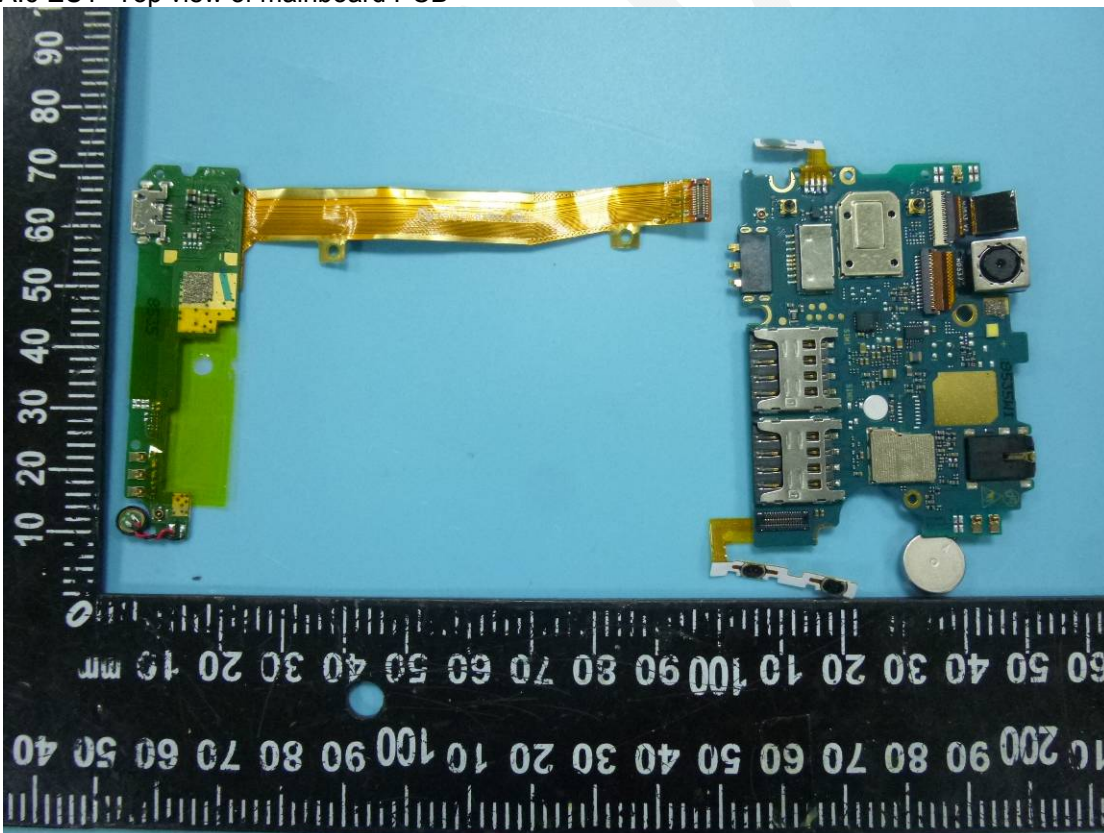

A.7 EUT- Bottom view of mainboard PCB

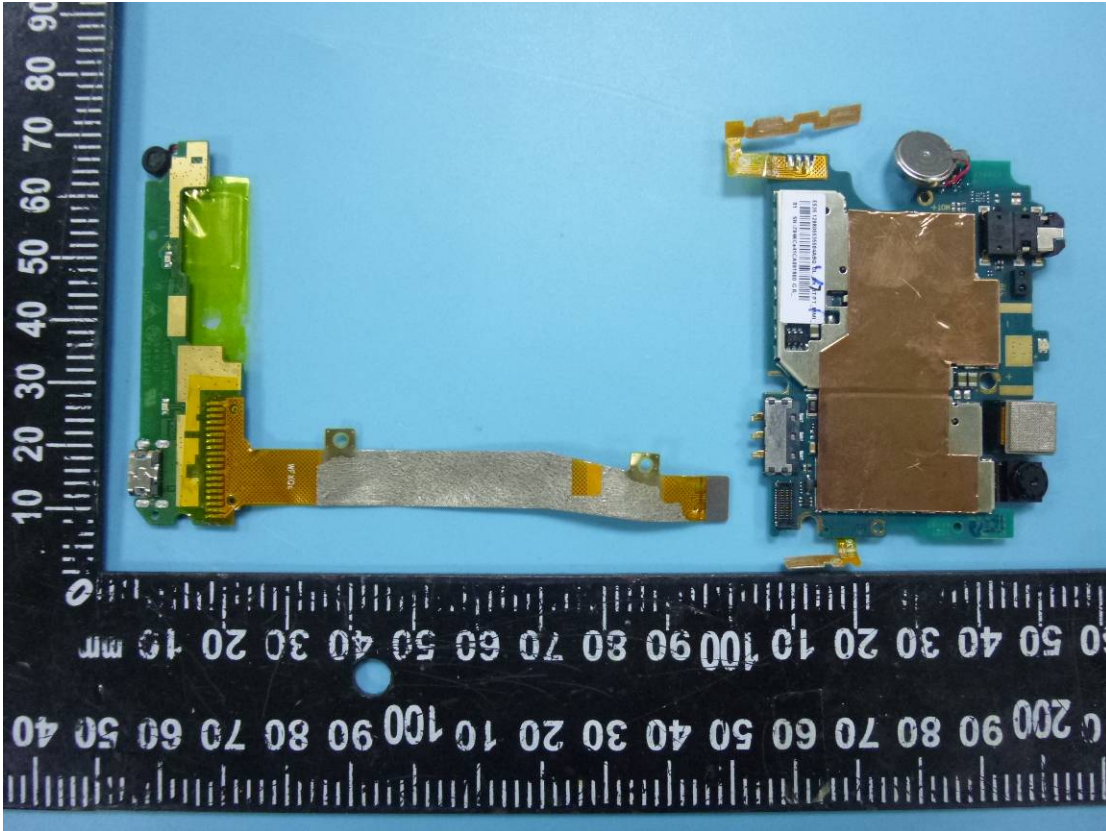

A.8 EUT-Bottom view of LCM

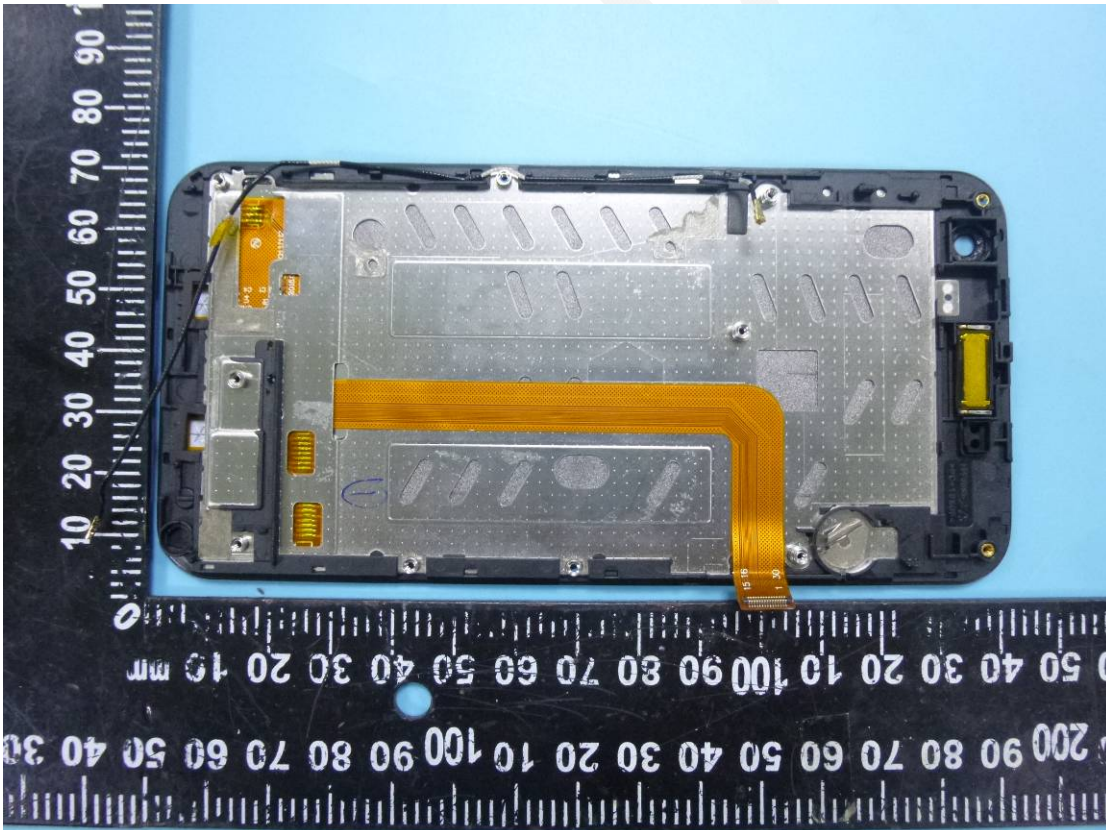

Important Safety Instructions

1. Use the approved adapter specified by manufacturer.

Manufacture: Shenzhen JINGRICHANG Electronic Technology Co., Ltd

Model: JT108-0501000

Rated Input: 100-240V~ 50/60Hz 0.2A

Output: 5.0 Vdc 1000 mA(L.P.S.)

2. To prevent possible hearing damage, do not listen at high volume levels for long periods.



2. Please use appointed battery in case of explosion risk, please dispose of lifeless battery under guidance.

4. Recycle your phone



The WEEE logo (shown at the left) appears on the product to indicate that this product must not be disposed off or dumped with your other household wastes. You are liable to dispose of all your electronic or electrical waste equipment by relocating over to the specified collection point for recycling. of such hazardous waste.

SAVE THESE INSTRUCTIONS

Appendix C – Schematics diagram of battery protection circuit

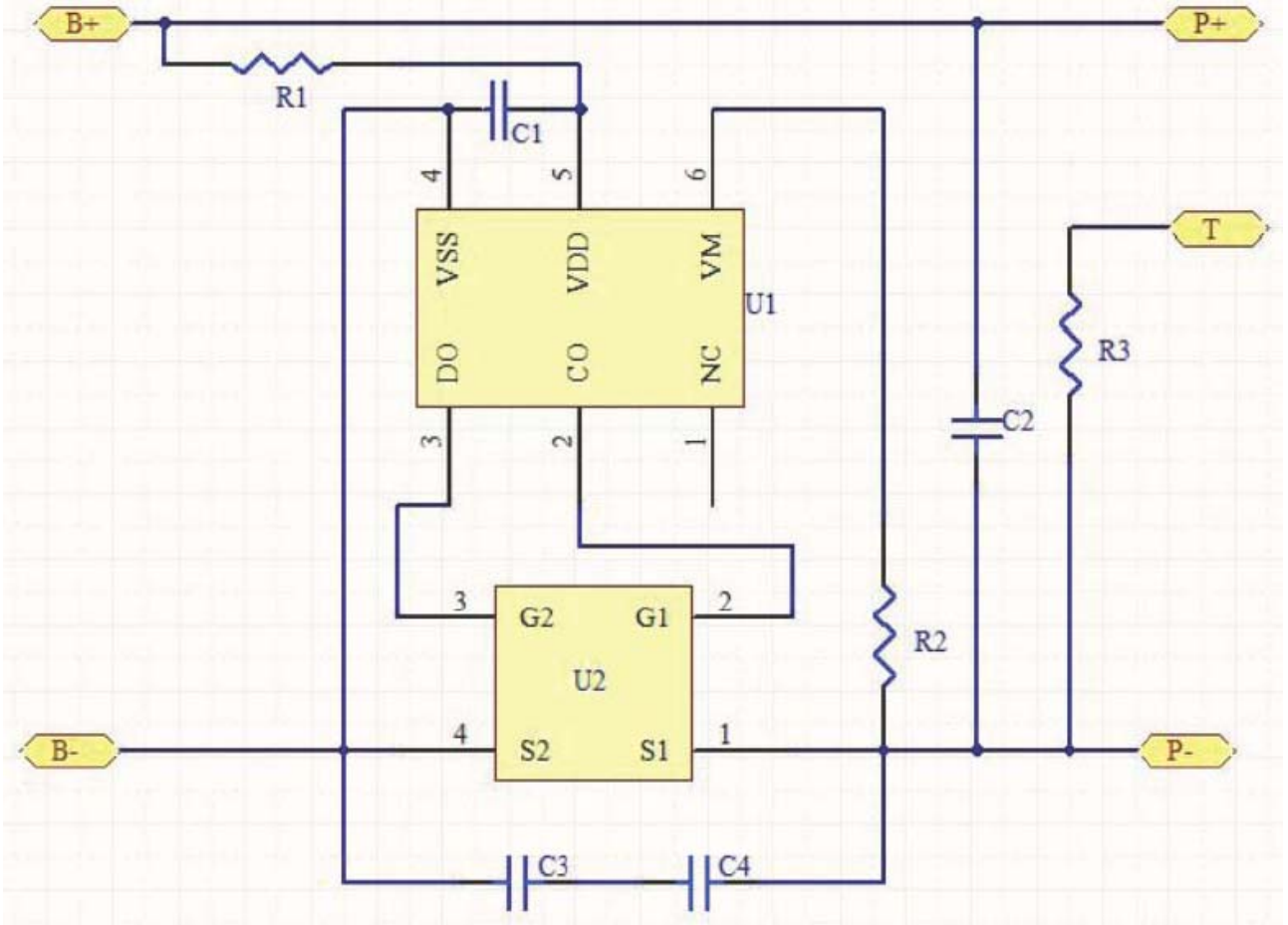

Appendix D –PCB Layout

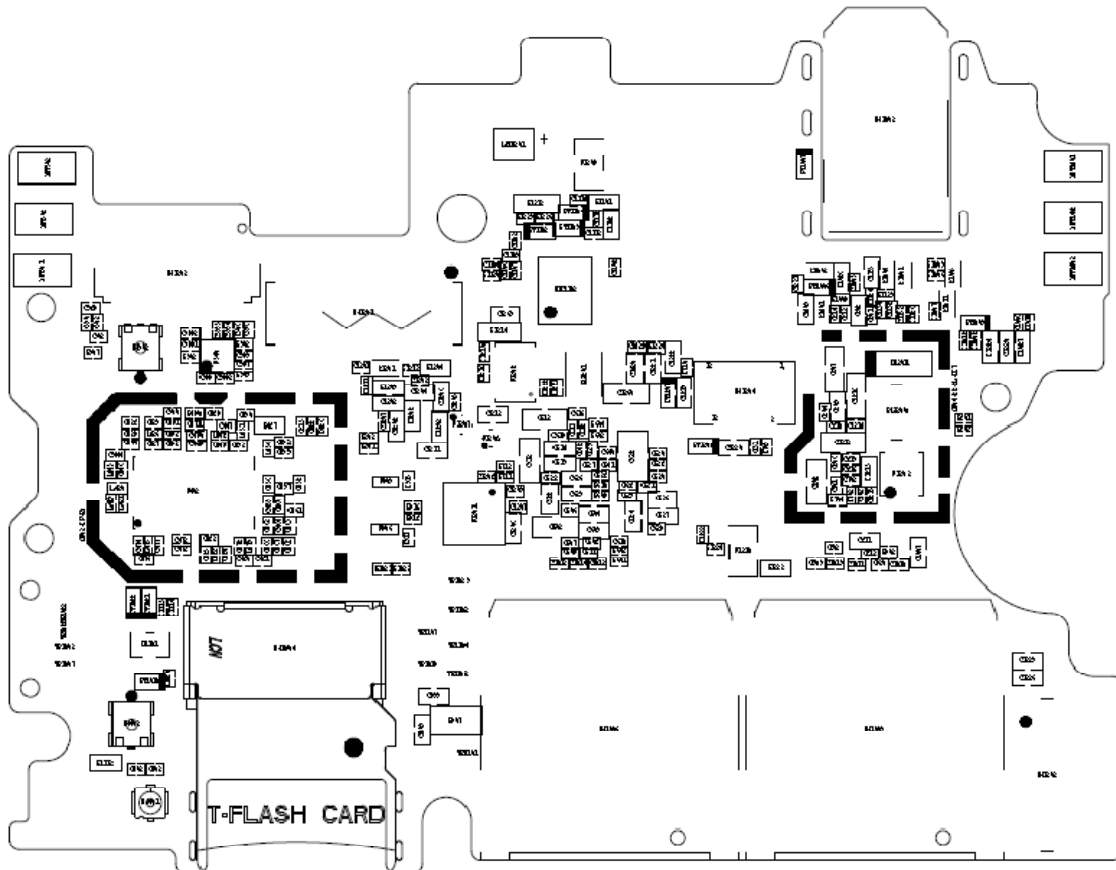
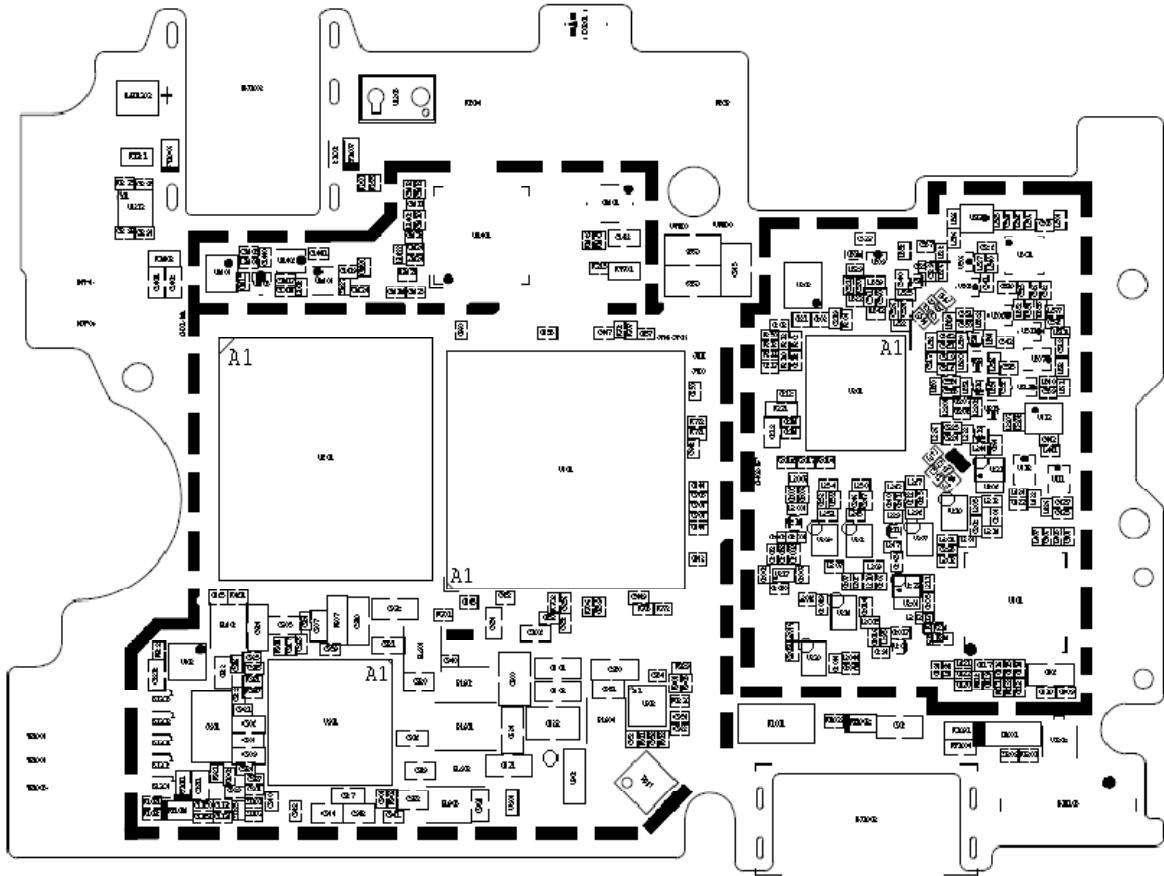



Shenzhen POCE Technology Co., Ltd.

H Building, HongFa Science and Technology Park,
Tangtou, Shiyan, Bao'an District, Shenzhen, China

CERTIFICATE OF CONFORMITY

Certificate No. : POCE16012008CCS
Applicant : Shenzhen JINGRICHANG Electronic Technology Co., Ltd
Address : 4# Liaokeng Road, Shiyan Town, Bao'an District , Shenzhen
Manufacturer : Shenzhen JINGRICHANG Electronic Technology Co., Ltd
Address : 4# Liaokeng Road, Shiyan Town, Bao'an District , Shenzhen
Product : AC Adapter
Trade Name : N/A
Model(s) : JT108-0501000, JT108-050500, JT108-050550 JT108-050600,
JT108-050650, JT108-050700, JT108-050800
Rating : Input: 100-240V~, 50/60Hz, 0.2A
Output: 5V---1A
Test Report No. : POCE16012008CRS
Test Standards : EN 60950-1: 2006+A11: 2009+A1: 2010+A12: 2011+A2: 2013

The EUT described above has been tested by us with the listed standards and found in compliance with the council **LVD Directive 2014/35/EU**. It is possible to use **CE** marking to demonstrate the compliance with this LVD Directive.

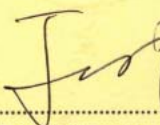

.....
For Chief Executive /
Date: Jan. 26, 2016



This certificate of conformity is based on a single evaluation of the submitted sample(s) of the above mentioned product. It does not imply an assessment of the whole production and other relevant directives have to be observed.

Web: <http://www.poce-cert.com>

Tel: +86-755-29113252

Fax: +86-755-29113135

Appendix F- Test Equipments list

NO.	The Name of Equipment	Model	S/N	Calibration Date	Due Date	Capability Range	Manufacturer
T-03-SF184	AC Power Meter	WT210	91K610292	2015-11-3	2016-11-2	AC : 0-600V 0-20A 0-5KW DC : 0-100V 0-10A 0-300W	YOKOGAWA
T-03-SF133	Electronic Load	3710.5A	A06BG03033	2015-11-3	2016-11-2	0-360V , 0-30A , 0-300W	Array Electronic
T-03-SF251	Temperature & Humidity Meter	T218	E0942	2016-1-8	2017-1-7	15-30°C, 30-90%RH	N/A
T-03-SF153	test finger	N/A	N/A	2015-4-10	2016-4-9	12.7mm	N/A
T-03-SF208	Data acquisition instrument	34970A	N/A	2015-4-10	2016-4-9	0-200°C	Agilent
T-03-SF210	Digital multimeter	17B	16284529	2015-4-10	2016-4-9	0-1000VAC/DC, 0-10A AC/DC, 0-40Mohm	Fluke
T-03-SF021	Push & Pull Tester	SN-500	2601050032	2015-4-10	2016-4-9	0-50kg	SUNDOO
T-03-SF183	Stopwatch	PC396	N/A	2015-4-10	2016-4-9	0-3600s/3.0s/d	TianFu
T-03-SF027	Electron Balance	ACS-30	40136285	2015-11-3	2016-11-2	0~30kg	Huade
T-03-EM328	Audio Analyzer	UPV	1146.2003K02-101782-XP	2015-6-2	2016-6-1	N/A	R&S
T-03-EM336	Head and Torso Simulator	4128C	2562220	2015-6-4	2016-6-3	N/A	Brüel & Kjær
T-03-EM319	Measuring Amplifier	Type 2636	1118355	2015-12-7	2016-12-6	N/A	B&K