

ETSI EN 300 328 V2.1.1 (2016-11)

TEST REPORT

For

Vonino Electronics Limited

Miramar Tower 10F - no1010, 132 Nathan Road, Tsim Sha Tsui, Kowloon, Hong Kong

Model: Xavy G7

Report Type: Amended Report	Product Type: Tablet PC
Report Number:	RSZ170523002-22CA1
Report Date:	2017-06-08
Reviewed By:	RF Engineer
Prepared By:	Bay Area Compliance Laboratories Corp. (Shenzhen) 6/F., West Wing, Third Phase of Wanli Industrial Building, Shihua Road, Futian Free Trade Zone, Shenzhen, Guangdong, China Tel: +86-755-33320018 Fax: +86-755-33320008 www.baclcorp.com.cn

Note: This test report is prepared for the customer shown above and for the equipment described herein. It may not be duplicated or used in part without prior written consent from Bay Area Compliance Laboratories Corp. This report is valid only with a valid digital signature. The digital signature may be available only under the Adobe software above version 7.0.

TABLE OF CONTENTS

DOCUMENT REVISION HISTORY	3
BELOW IS THE REFERENCED REPORT	4

DRAFT

DOCUMENT REVISION HISTORY

Revision Number	Report Number	Description of Revision	Date of Issue
0	RSZ170417008-22C	Original Report	2017-05-02
1	RSZ170523002-22CA1	Amended Report	2017-06-08

Note:

This is an amended report application based on original report, the details as below:

1. Change the applicant to “Vonino Electronics Limited”.
2. Change the applicant address to “Miramar Tower 10F - no1010, 132 Nathan Road, Tsim Sha Tsui, Kowloon, Hong Kong”
3. Change the model to “Xavy G7”.
4. Change the trade name to “Vonino”.

Based on the above difference, it will affect nothing, so all the data and photos please refer to the original report.

BELOW IS THE REFERENCED REPORT

ETSI EN 300 328 V2.1.1 (2016-11)

TEST REPORT

For

Shenzhen Adreamer Technology Co.,Ltd

Building A2, Silicon Valley Dynamic Qinghu Garden, Dahe Rd.,Longhua, Shenzhen, China

Tested Model: MK6952
Multiple Model: Xavy G7

Report Type: Original Report	Product Type: Tablet PC
Report Number:	RSZ170417008-22C
Report Date:	2017-05-02
Reviewed By:	Simon Wang <i>Simon wang</i> RF Engineer
Prepared By:	Bay Area Compliance Laboratories Corp. (Shenzhen) 6/F., West Wing, Third Phase of Wanli Industrial Building, Shihua Road, Futian Free Trade Zone, Shenzhen, Guangdong, China Tel: +86-755-33320018 Fax: +86-755-33320008 www.baclcorp.com.cn

Note: This test report is prepared for the customer shown above and for the equipment described herein. It may not be duplicated or used in part without prior written consent from Bay Area Compliance Laboratories Corp. This report is valid only with a valid digital signature. The digital signature may be available only under the Adobe software above version 7.0.

TABLE OF CONTENTS

GENERAL INFORMATION.....	4
PRODUCT DESCRIPTION FOR EQUIPMENT UNDER TEST (EUT).....	4
OBJECTIVE.....	4
RELATED SUBMITTAL(S)/GRANT(S).....	4
TEST METHODOLOGY.....	4
MEASUREMENT UNCERTAINTY.....	5
TEST FACILITY.....	5
SYSTEM TEST CONFIGURATION.....	6
DESCRIPTION OF TEST CONFIGURATION.....	6
EUT EXERCISE SOFTWARE.....	6
SPECIAL ACCESSORIES.....	6
EQUIPMENT MODIFICATIONS.....	7
SUPPORT EQUIPMENT LIST AND DETAILS.....	7
EXTERNAL I/O CABLE.....	7
BLOCK DIAGRAM OF TEST SETUP.....	7
SUMMARY OF TEST RESULTS.....	8
TEST EQUIPMENT LIST.....	9
ETSI EN 300 328 V2.1.1 (2016-11) §4.3.2.2 – RF OUTPUT POWER.....	10
APPLICABLE STANDARD.....	10
TEST PROCEDURE.....	10
TEST DATA.....	11
ETSI EN 300 328 V2.1.1 (2016-11) §4.3.2.3 - POWER SPECTRAL DENSITY.....	14
APPLICABLE STANDARD.....	14
TEST PROCEDURE.....	14
TEST SETUP BLOCK DIAGRAM.....	17
TEST DATA.....	17
ETSI EN 300 328 V2.1.1 (2016-11) §4.3.2.7 – OCCUPIED CHANNEL BANDWIDTH.....	24
APPLICABLE STANDARD.....	24
TEST PROCEDURE.....	24
TEST DATA.....	25
ETSI EN 300 328 V2.1.1 (2016-11) §4.3.2.8 – TRANSMITTER UNWANTED EMISSION IN THE OUT-OF-BAND DOMAIN.....	30
APPLICABLE STANDARD.....	30
TEST PROCEDURE.....	30
TEST DATA.....	30
ETSI EN 300 328 V2.1.1 (2016-11) §4.3.2.9 – TRANSMITTER UNWANTED EMISSION IN THE SPURIOUS DOMAIN.....	35
APPLICABLE STANDARD.....	35
TEST PROCEDURE.....	35
TEST DATA.....	35
ETSI EN 300 328 V2.1.1 (2016-11) §4.3.2.10 – RECEIVER SPURIOUS EMISSIONS.....	38
APPLICABLE STANDARD.....	38
TEST PROCEDURE.....	38

TEST DATA	38
ETSI EN 300 328 V2.1.1 (2016-11) §4.3.2.11 - RECEIVER BLOCKING	40
APPLICABLE STANDARD	40
TEST PROCEDURE	41
TEST DATA	42
EXHIBIT A - E.2 INFORMATION AS REQUIRED BY EN 300 328 V2.1.1, CLAUSE 5.4.1.....	44
EXHIBIT B - EUT PHOTOGRAPHS	49
EUT – ALL VIEW	49
EUT – FRONT VIEW	49
EUT – REAR VIEW	50
EUT – TOP VIEW	50
EUT – BOTTOM VIEW	51
EUT – LEFT VIEW	51
EUT – RIGHT VIEW	52
EUT – COVER OFF VIEW 1	52
EUT – COVER OFF VIEW 2	53
EUT – COVER OFF VIEW 3	53
EUT – COVER OFF VIEW 4	54
EUT – MAIN BOARD TOP VIEW	54
EUT – MAIN BOARD TOP SHIELDING OFF VIEW	55
EUT – MAIN BOARD BOTTOM VIEW	55
EUT – IC CHIP VIEW	56
EUT – ADAPTER VIEW	56
EUT – ADAPTER LABEL VIEW	57
EUT – BATTERY FRONT VIEW	57
EUT – BATTERY REAR VIEW	58
EXHIBIT C - TEST SETUP PHOTOGRAPHS	59
RADIATED SPURIOUS EMISSIONS TEST VIEW (BELOW 1GHz)	59
RADIATED SPURIOUS EMISSIONS TEST VIEW (ABOVE 1GHz)	59

GENERAL INFORMATION

Product Description for Equipment under Test (EUT)

The *Shenzhen Adreamer Technology Co., Ltd's* product, model number: *MK6952* in this report is a *Tablet PC*, which was measured approximately: 186 mm (L) * 101mm (W) * 9.6mm (H), rated with input voltage: DC 3.7V from rechargeable li-ion battery or DC 5.0V from adapter.

Adapter information

Model: C2000

Input: AC 100-240V 50/60Hz 0.3A

Output: DC 5.0V, 2.0A

Notes: This series products model: Xavy G7 and MK6952 are identical; they have the same or similar appearance, structure, PCB, Material and function to the testing products, and only are different for model name. Model MK6952 was selected for fully testing, the detailed information can be referred to the attached declaration which was stated and guaranteed by the applicant.

** All measurement and test data in this report was gathered from production sample serial number: 1700688 (Assigned by BACL, Shenzhen).The EUT supplied by the applicant was received on 2017-04-17.*

Objective

This report is prepared on behalf of *Shenzhen Adreamer Technology Co., Ltd* in accordance with ETSI EN 300 328 V2.1.1 (2016-11), Wideband transmission systems; Data transmission equipment operating in the 2,4 GHz ISM band and using wide band modulation techniques; Harmonised Standard covering the essential requirements of article 3.2 of Directive 2014/53/EU

The objective is to determine the compliance of EUT with ETSI EN 300 328 V2.1.1 (2016-11).

Related Submittal(s)/Grant(s)

No related submittal(s).

Test Methodology

All measurements contained in this report were conducted with ETSI EN 300 328 V2.1.1 (2016-11).

Measurement Uncertainty

Parameter	Flab	Maximum allow uncertainty
Occupied Channel Bandwidth	±5%	±5%
RF output power, conducted	±1.5dB	±1.5dB
Power Spectral Density, conducted	±1.5dB	±3dB
Unwanted Emission, conducted	±1.5dB	±3dB
All emissions, radiated	±4.88dB	±6dB
Temperature	±1 °C	±3 °C
Supply voltages	±0.4%	±3%
Time	±1%	±5%

Test Facility

The test site used by Bay Area Compliance Laboratories Corp. (Shenzhen) to collect test data is located on the 6/F., West Wing, Third Phase of Wanli Industrial Building, Shihua Road, Futian Free Trade Zone, Shenzhen, Guangdong, China.

Test site at Bay Area Compliance Laboratories Corp. (Shenzhen) has been fully described in reports submitted to the Federal Communication Commission (FCC). The details of these reports have been found to be in compliance with the requirements of Section 2.948 of the FCC Rules on October 31, 2013. The facility also complies with the radiated and AC line conducted test site criteria set forth in ANSI C63.4-2014.

The Federal Communications Commission has the reports on file and is listed under FCC Registration No.: 382179. The test site has been approved by the FCC for public use and is listed in the FCC Public Access Link (PAL) database.

SYSTEM TEST CONFIGURATION

Description of Test Configuration

For 802.11b, 802.11g and 802.11n-HT20 mode, 13 channels are provided to testing:

Channel	Frequency (MHz)	Channel	Frequency (MHz)
1	2412	8	2447
2	2417	9	2452
3	2422	10	2457
4	2427	11	2462
5	2432	12	2467
6	2437	13	2472
7	2442	/	/

EUT was tested with Channel 1, 7 and 13.

For 802.11n-HT40 mode, 9 channels are provided to testing:

Channel	Frequency (MHz)	Channel	Frequency (MHz)
1	2422	6	2447
2	2427	7	2452
3	2432	8	2457
4	2437	9	2462
5	2442	/	/

EUT was tested with Channel 1, 5 and 9.

The worst-case data rates are determined to be as follows for each mode based upon investigation by measuring the average power and PSD across all data rates bandwidths, and modulations.

EUT Exercise Software

The device was tested with 100% duty cycle and the worst case was performed under:

802.11b: Data rate: 1 Mbps, power level: 14

802.11g: Data rate: 6 Mbps, power level: 13

802.11n-HT20: Data rate: MCS0, power level: 13

802.11n-HT40: Data rate: MCS0, power level: 13

Special Accessories

No special accessory.

Equipment Modifications

No modification was made to the EUT.

Support Equipment List and Details

Manufacturer	Description	Model	Serial Number
/	/	/	/

External I/O Cable

Cable Description	Length (m)	From Port	To
/	/	/	/

Block Diagram of Test Setup

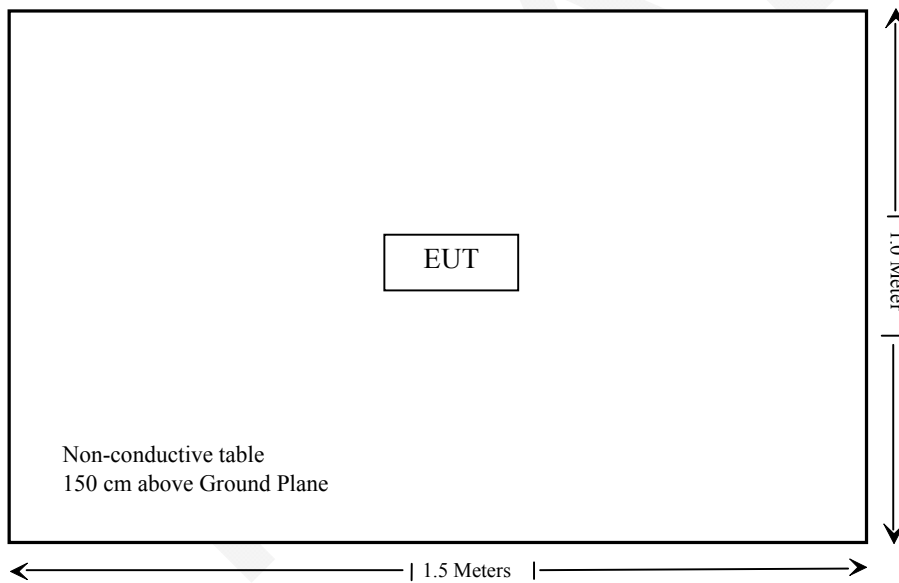

SUMMARY OF TEST RESULTS

ETSI EN 300 328 V2.1.1 (2016-11)	Description of Test	Test Result
§4.3.2.2	RF output power	Compliance
§ 4.3.2.3	Power Spectral Density	Compliance
§ 4.3.2.4	Duty Cycle, Tx-sequence, Tx-gap	Not Applicable
§ 4.3.2.5	Medium Utilization (MU) factor	Not Applicable
§ 4.3.2.6	Adaptivity	Not Applicable*
§ 4.3.2.7	Occupied Channel Bandwidth	Compliance
§ 4.3.2.8	Transmitter unwanted emissions in the out-of-band domain	Compliance
§ 4.3.2.9	Transmitter unwanted emissions in the spurious domain	Compliance
§ 4.3.2.10	Receiver spurious emissions	Compliance
§ 4.3.2.11	Receiver Blocking	Compliance
§ 4.3.2.12	Geo-location capability	Not Applicable**

Note:

The supplier declared that the equipment is adaptive equipment

Not Applicable – This item only for non-adaptive equipment

Not Applicable* –The test item does not apply for equipment within a maximum RF output power level of less than 10 dBm (e.i.r.p).

Not Applicable** –The supplier declared that the equipment has no this function.

TEST EQUIPMENT LIST

Manufacturer	Description	Model	Serial Number	Calibration Date	Calibration Due Date
Radiated Emission Test					
Sunol Sciences	Horn Antenna	DRH-118	A052604	2014-12-29	2017-12-28
BIZI	Signal Analyzer	FSEM	845987/005	2017-04-14	2018-04-14
Sunol Sciences	Bi-log Antenna	JB1	A040904-2	2014-12-17	2017-12-16
Mini	Pre-amplifier	ZVA-183-S+	5969001149	2017-02-14	2018-02-14
HP	Amplifier	HP8447E	1937A01046	2016-11-12	2017-05-13
Anritsu	Signal Generator	68369B	004114	2016-12-05	2017-12-05
Rohde & Schwarz	EMI Test Receiver	ESCI	101120	2016-12-07	2017-12-07
COM POWER	Dipole Antenna	AD-100	041000	NCR	NCR
A.H. System	Horn Antenna	SAS-200/571	135	2015-08-18	2018-08-17
RF Conducted Test					
Agilent	P-Series Power Meter	N1912A	MY5000448	2016-12-05	2017-12-05
ESPEC	Temperature & Humidity Chamber	EL-10KA	09107726	2016-11-22	2017-11-22
Agilent	Wideband Power Sensor	N1921A	MY54210016	2016-12-05	2017-12-05
Anritsu	Signal Generator	68369B	004114	2016-12-05	2017-12-05
Rohde & Schwarz	Wideband Radio Communication Tester	CMW500	1201.002K50-146520-wh	2017-04-14	2018-04-14
TRILITHIC ASIA	Adjustable attenuator	RSA-2570D-SMA	T200537364	Each time	
Rohde & Schwarz	SPECTRUM ANALYZER	FSU26	200120	2016-12-05	2017-12-05

* **Statement of Traceability:** Bay Area Compliance Laboratories Corp. (Shenzhen) attests that all calibrations have been performed in accordance to requirements that traceable to National Primary Standards and International System of Units (SI).

ETSI EN 300 328 V2.1.1 (2016-11) §4.3.2.2 – RF OUTPUT POWER

Applicable Standard

This requirement applies to all types of equipment using wide band modulations other than FHSS.

The RF output power is defined as the mean equivalent isotropic radiated power (e.i.r.p.) of the equipment during a transmission burst.

For adaptive equipment using wide band modulations other than FHSS, the maximum RF output power shall be 20 dBm.

The maximum RF output power for non-adaptive equipment shall be declared by the manufacturer and shall not exceed 20 dBm. See clause 5.4.1 m). For non-adaptive equipment using wide band modulations other than FHSS, the maximum RF output power shall be equal to or less than the value declared by the manufacturer.

This limit shall apply for any combination of power level and intended antenna assembly.

Test Procedure

The test procedure shall be as follows:

Step 1:

- Use a fast power sensor suitable for 2,4 GHz and capable of minimum 1 MS/s.
- Use the following settings:
 - Sample speed 1 MS/s or faster.
 - The samples shall represent the RMS power of the signal.
 - Measurement duration: For non-adaptive equipment: equal to the observation period defined in clause 4.3.1.3.2 or clause 4.3.2.4.2. For adaptive equipment, the measurement duration shall be long enough to ensure a minimum number of bursts (at least 10) are captured.

NOTE 1: For adaptive equipment, to increase the measurement accuracy, a higher number of bursts may be used.

Step 2:

- For conducted measurements on devices with one transmit chain:
 - Connect the power sensor to the transmit port, sample the transmit signal and store the raw data. Use these stored samples in all following steps.
- For conducted measurements on devices with multiple transmit chains:
 - Connect one power sensor to each transmit port for a synchronous measurement on all transmit ports.
 - Trigger the power sensors so that they start sampling at the same time. Make sure the time difference between the samples of all sensors is less than 500 ns.
 - For each individual sampling point (time domain), sum the coincident power samples of all ports and store them. Use these summed samples as the new stored data set.

Step 3:

- Find the start and stop times of each burst in the stored measurement samples.
The start and stop times are defined as the points where the power is at least 30 dB below the highest value of the stored samples in step 2.

NOTE 2: In case of insufficient dynamic range, the value of 30 dB may need to be reduced appropriately.

Step 4:

- Between the start and stop times of each individual burst calculate the RMS power over the burst using the formula below. Save these Pburst values, as well as the start and stop times for each burst.

$$P_{burst} = \frac{1}{k} \sum_{n=1}^k P_{sample}(n)$$

with 'k' being the total number of samples and 'n' the actual sample number

Step 5:

- The highest of all Pburst values (value "A" in dBm) will be used for maximum e.i.r.p. calculations.

Step 6:

- Add the (stated) antenna assembly gain "G" in dBi of the individual antenna.
- If applicable, add the additional beamforming gain "Y" in dB.
- If more than one antenna assembly is intended for this power setting, the maximum overall antenna gain (G or G + Y) shall be used.
- The RF Output Power (P) shall be calculated using the formula below:

$$P = A + G + Y$$

- This value, which shall comply with the limit given in clause 4.3.1.2.3 or clause 4.3.2.2.3, shall be recorded in the test report.

Test Data**Environmental Conditions**

Temperature:	25 °C
Relative Humidity:	50 %
ATM Pressure:	101.0 kPa

The testing was performed by Dylan Li on 2017-04-19.

EUT operation mode: Transmitting

Test Result: Compliant, please refer to following table.

802.11b Mode

Test Condition			Ave. Output Power (dBm)	Antenna Gain (dBi)	EIRP (dBm)	Limits (dBm)	Test Results
Channel	Temperature (°C)	Voltage (V _{DC})					
Low	-20	3.7	8.35	0.5	8.85	20	Compliant
	+25	3.7	8.32	0.5	8.82	20	Compliant
	+55	3.7	8.29	0.5	8.79	20	Compliant
Middle	-20	3.7	8.55	0.5	9.05	20	Compliant
	+25	3.7	8.51	0.5	9.01	20	Compliant
	+55	3.7	8.54	0.5	9.04	20	Compliant
High	-20	3.7	7.81	0.5	8.31	20	Compliant
	+25	3.7	7.79	0.5	8.29	20	Compliant
	+55	3.7	7.83	0.5	8.33	20	Compliant

802.11g Mode

Test Condition			Ave. Output Power (dBm)	Antenna Gain (dBi)	EIRP (dBm)	Limits (dBm)	Test Results
Channel	Temperature (°C)	Voltage (V _{DC})					
Low	-20	3.7	8.22	0.5	8.72	20	Compliant
	+25	3.7	8.20	0.5	8.70	20	Compliant
	+55	3.7	8.25	0.5	8.75	20	Compliant
Middle	-20	3.7	8.34	0.5	8.84	20	Compliant
	+25	3.7	8.36	0.5	8.86	20	Compliant
	+55	3.7	8.31	0.5	8.81	20	Compliant
High	-20	3.7	8.01	0.5	8.51	20	Compliant
	+25	3.7	8.05	0.5	8.55	20	Compliant
	+55	3.7	8.06	0.5	8.56	20	Compliant

802.11n-HT20 Mode

Test Condition			Ave. Output Power (dBm)	Antenna Gain (dBi)	EIRP (dBm)	Limits (dBm)	Test Results
Channel	Temperature (°C)	Voltage (V _{DC})					
Low	-20	3.7	8.14	0.5	8.64	20	Compliant
	+25	3.7	8.19	0.5	8.69	20	Compliant
	+55	3.7	8.22	0.5	8.72	20	Compliant
Middle	-20	3.7	8.43	0.5	8.93	20	Compliant
	+25	3.7	8.40	0.5	8.90	20	Compliant
	+55	3.7	8.35	0.5	8.85	20	Compliant
High	-20	3.7	8.01	0.5	8.51	20	Compliant
	+25	3.7	8.03	0.5	8.53	20	Compliant
	+55	3.7	8.05	0.5	8.55	20	Compliant

802.11n-HT40 Mode

Test Condition			Ave. Output Power (dBm)	Antenna Gain (dBi)	EIRP (dBm)	Limits (dBm)	Test Results
Channel	Temperature (°C)	Voltage (V _{DC})					
Low	-20	3.7	8.11	0.5	8.61	20	Compliant
	+25	3.7	8.15	0.5	8.65	20	Compliant
	+55	3.7	8.17	0.5	8.67	20	Compliant
Middle	-20	3.7	8.43	0.5	8.93	20	Compliant
	+25	3.7	8.44	0.5	8.94	20	Compliant
	+55	3.7	8.46	0.5	8.96	20	Compliant
High	-20	3.7	8.04	0.5	8.54	20	Compliant
	+25	3.7	8.06	0.5	8.56	20	Compliant
	+55	3.7	8.07	0.5	8.57	20	Compliant

ETSI EN 300 328 V2.1.1 (2016-11) §4.3.2.3 - POWER SPECTRAL DENSITY

Applicable Standard

According to ETSI EN 300 328 V2.1.1 (2016-11) §4.3.2.3.2, this requirement applies to all types of equipment using wide band modulations other than FHSS.

The Power Spectral Density is the mean equivalent isotropically radiated power (e.i.r.p.) spectral density in a 1 MHz bandwidth during a transmission burst.

For equipment using wide band modulations other than FHSS, the maximum Power Spectral Density is limited to 10 dBm per MHz.

Test Procedure

Option 1: For equipment with continuous and non-continuous transmissions

The transmitter shall be connected to a spectrum analyser and the Power Spectral Density as defined in clause 4.3.2.3 shall be measured and recorded.

The test procedure shall be as follows:

Step 1:

Connect the UUT to the spectrum analyser and use the following settings:

- Start Frequency: 2 400 MHz
- Stop Frequency: 2 483.5 MHz
- Resolution BW: 10 kHz
- Video BW: 30 kHz
- Sweep Points: > 8 350

NOTE: For spectrum analysers not supporting this number of sweep points, the frequency band may be segmented.

- Detector: RMS
- Trace Mode: Max Hold
- Sweep time:
For non-continuous transmissions: $2 \times \text{Channel Occupancy Time} \times \text{number of sweep points}$
For continuous transmissions: 10 s; the sweep time may be increased further until a value where the sweep time has no impact on the RMS value of the signal

For non-continuous signals, wait for the trace to stabilize.

Save the data (trace data) set to a file.

Step 2:

For conducted measurements on smart antenna systems using either operating mode 2 or operating mode 3 (see clause 5.3.2.2), repeat the measurement for each of the transmit ports. For each sampling point (frequency domain), add up the coincident power values (in mW) for the different transmit chains and use this as the new data set.

Step 3:

Add up the values for power for all the samples in the file using the formula below.

$$P_{Sum} = \frac{1}{k} \sum_{n=1}^k P_{sample}(n)$$

with 'k' being the total number of samples and 'n' the actual sample number

Step 4:

Normalize the individual values for power (in dBm) so that the sum is equal to the RF Output Power (e.i.r.p.) measured in clause 5.3.2 and save the corrected data. The following formulas can be used:

$$C_{Corr} = P_{Sum} - P_{e.i.r.p}$$

$$P_{Samplecorr}(n) = P_{Sample}(n) - C_{Corr}$$

with 'n' being the actual sample number

Step 5:

Starting from the first sample $P_{Samplecorr}(n)$ (lowest frequency), add up the power (in mW) of the following samples representing a 1 MHz segment and record the results for power and position (i.e. sample #1 to sample #100). This is the Power Spectral Density (e.i.r.p.) for the first 1 MHz segment which shall be recorded.

Step 6:

Shift the start point of the samples added up in step 5 by one sample and repeat the procedure in step 5 (i.e. sample #2 to sample #101).

Step 7:

Repeat step 6 until the end of the data set and record the Power Spectral Density values for each of the 1 MHz segments.

From all the recorded results, the highest value is the maximum Power Spectral Density for the UUT. This value, which shall comply with the limit given in clause 4.3.2.3.3, shall be recorded in the test report.

Option 2: For equipment with continuous transmission capability or for equipment operating (or with the capability to operate) with a constant duty cycle (e.g. Frame Based equipment)

This option is for equipment that can be configured to operate in a continuous transmit mode (100 % DC) or with a constant Duty Cycle (DC).

Step 1:

Connect the UUT to the spectrum analyser and use the following settings:

Centre Frequency: The centre frequency of the channel under test
RBW: 1 MHz
VBW: 3 MHz
Frequency Span: $2 \times$ Nominal Bandwidth (e.g. 40 MHz for a 20 MHz channel)
Detector Mode: Peak
Trace Mode: Max Hold

Step 2:

When the trace is complete, find the peak value of the power envelope and record the frequency.

Step 3:

Make the following changes to the settings of the spectrum analyser:

Centre Frequency: Equal to the frequency recorded in step 2
Frequency Span: 3 MHz
RBW: 1 MHz
VBW: 3 MHz
Sweep Time: 1 minute
Detector Mode: RMS
Trace Mode: Max Hold

Step 4:

When the trace is complete, the trace shall be captured using the "Hold" or "View" option on the spectrum analyser.

Find the peak value of the trace and place the analyser marker on this peak. This level is recorded as the highest mean power (power spectral density) D in a 1 MHz band.

Alternatively, where a spectrum analyser is equipped with a function to measure power spectral density, this function may be used to display the power spectral density D in dBm / MHz.

In case of conducted measurements on smart antenna systems operating in a mode with multiple transmit chains active simultaneously, the power spectral density of each transmit chain shall be measured separately to calculate the total power spectral density (value D in dBm / MHz) for the UUT.

Step 5:

The maximum Power Spectral Density (PSD) e.i.r.p. is calculated from the above measured power spectral density D , the observed Duty Cycle (DC) (see clause 5.4.2.2.1.3, step 4), the applicable antenna assembly gain G in dBi and if applicable the beamforming gain Y in dB, according to the formula below. This value shall be recorded in the test report. If more than one antenna assembly is intended for this power setting, the gain of the antenna assembly with the highest gain shall be used.

$PSD = D + G + Y + 10 \times \log(1 / DC)$ (dBm / MHz)

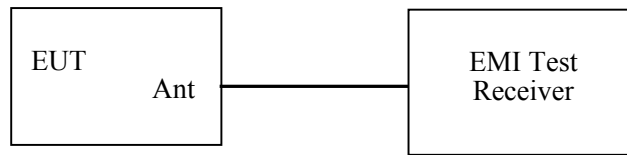
Test Setup Block diagram**Test Data****Environmental Conditions**

Temperature:	26 °C
Relative Humidity:	53 %
ATM Pressure:	101.0 kPa

The testing was performed by Dylan Li on 2017-05-01.

EUT operation mode: Transmitting

Test with Option 1 method.

Test Result: Compliant, please refer to following plots.

802.11b Mode, Low Channel: 2412 MHz

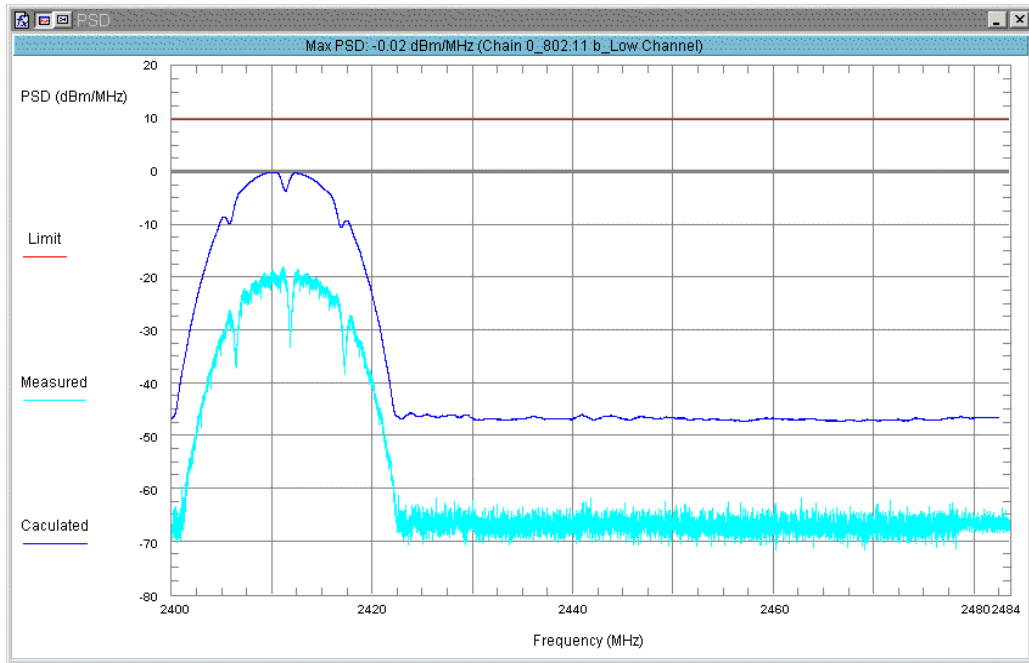

802.11b Mode, Middle Channel: 2442 MHz

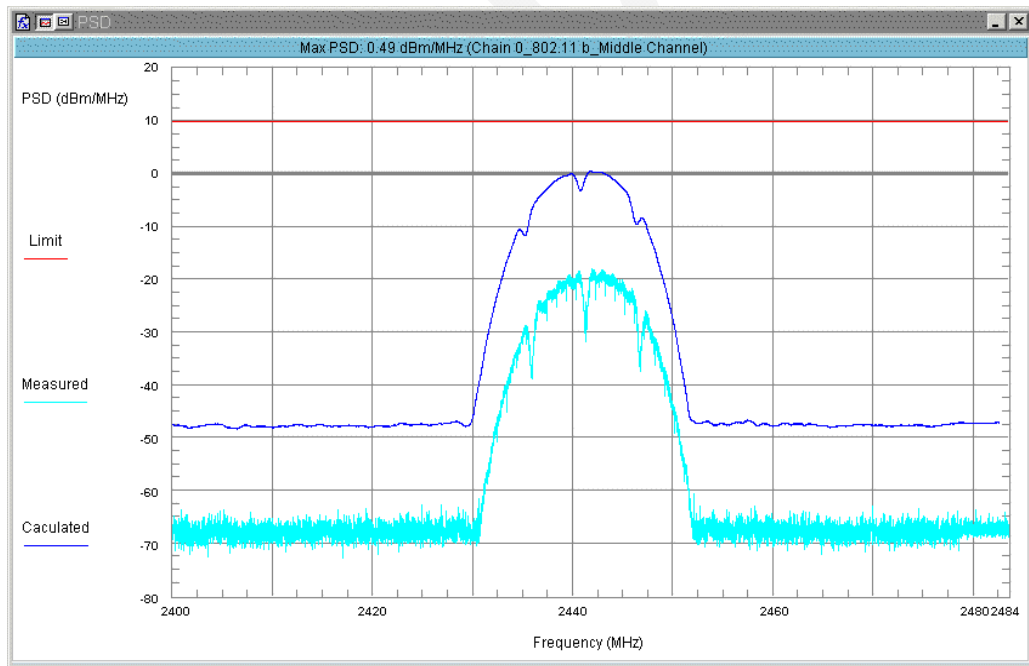

802.11b Mode, High Channel: 2472 MHz

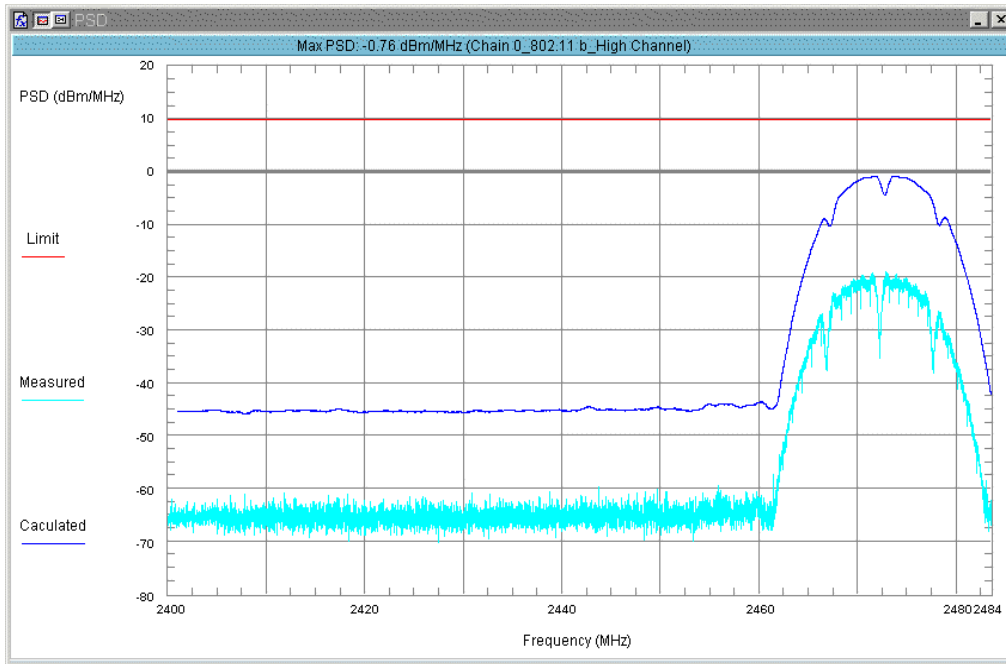

802.11g Mode, Low Channel: 2412 MHz

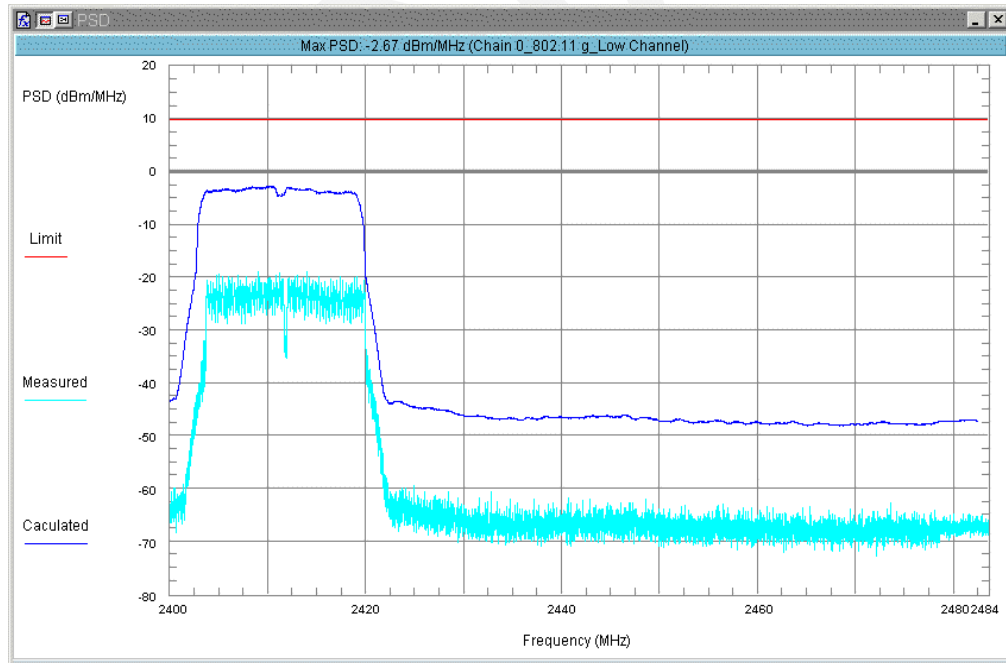

802.11g Mode, Middle Channel: 2442 MHz

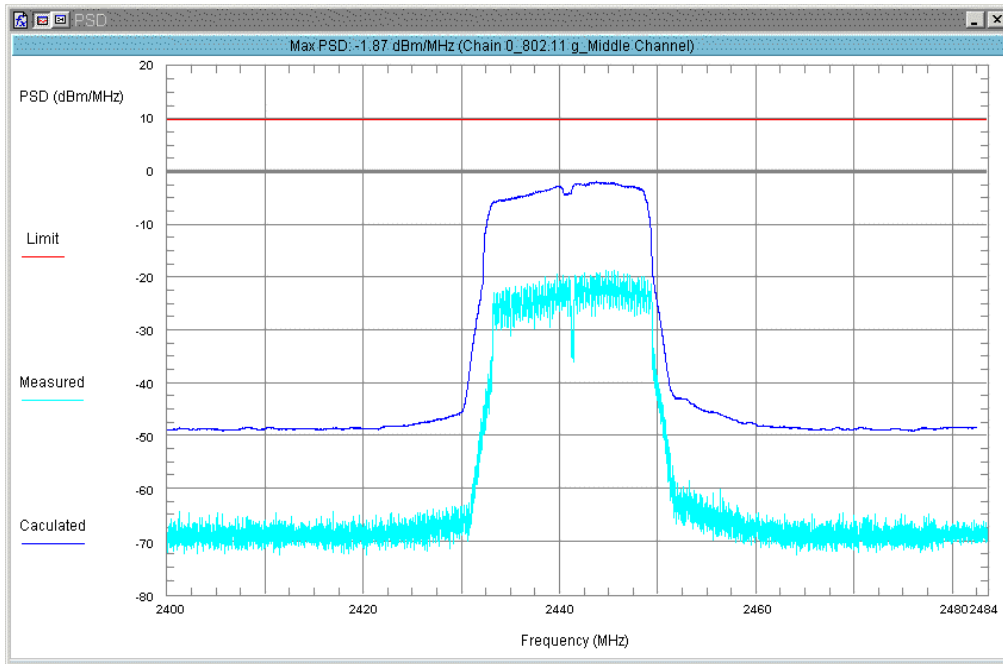

802.11g Mode, High Channel: 2472 MHz

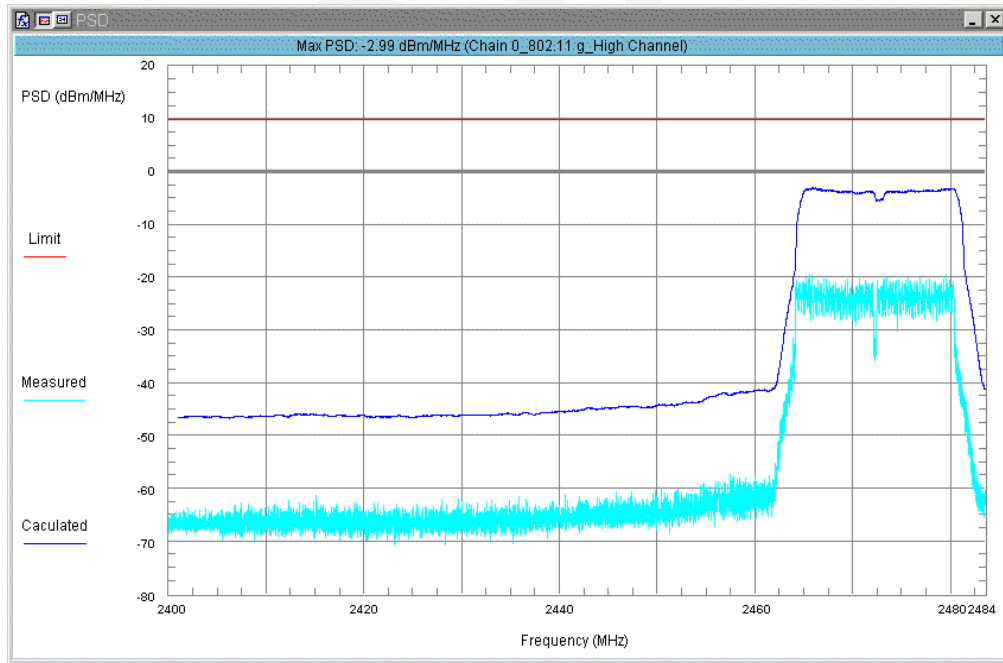

802.11n-HT20 Mode, Low Channel: 2412 MHz

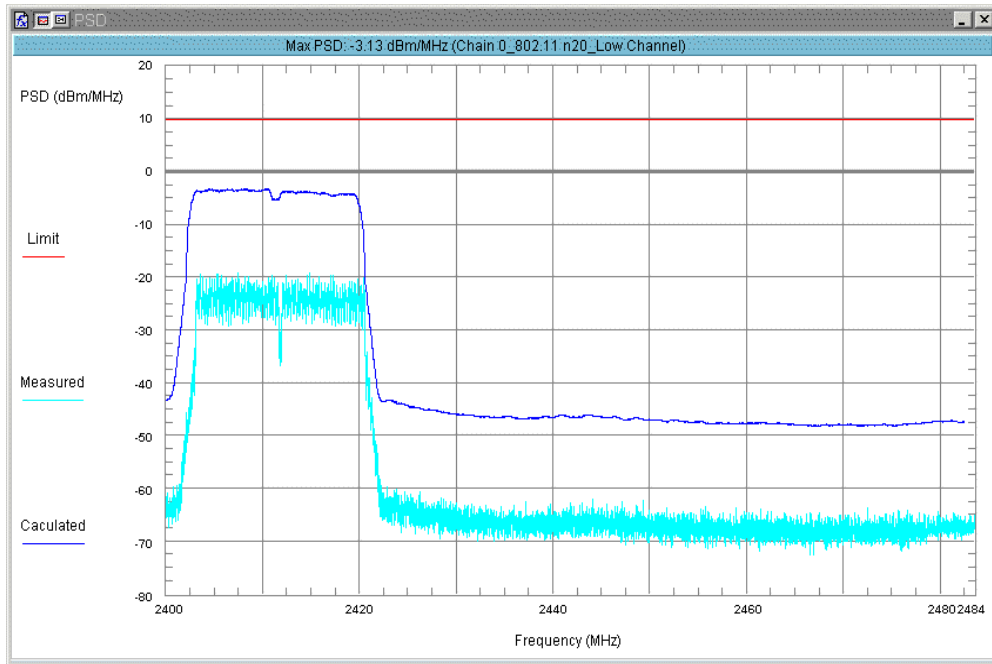

802.11n-HT20 Mode, Middle Channel: 2442 MHz

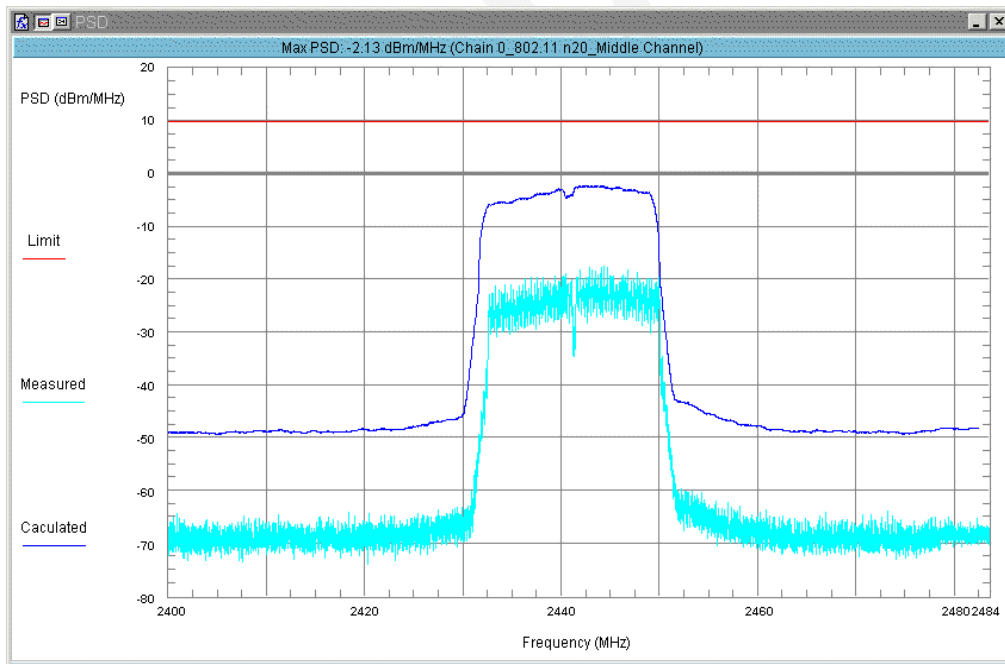

802.11n-HT20 Mode, High Channel: 2472 MHz

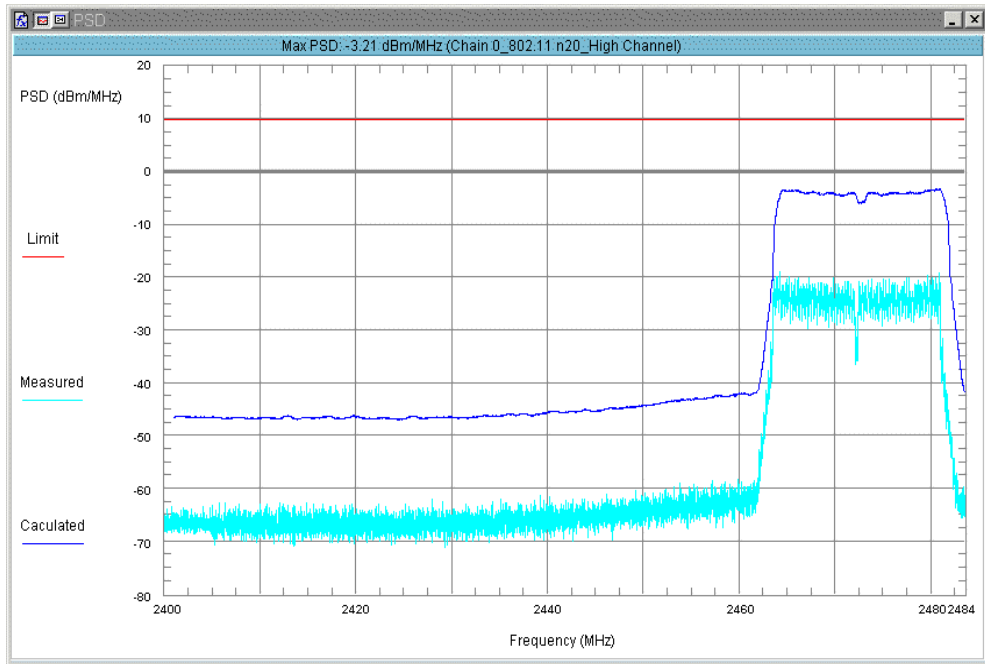

802.11n-HT40 Mode, Low Channel: 2422 MHz

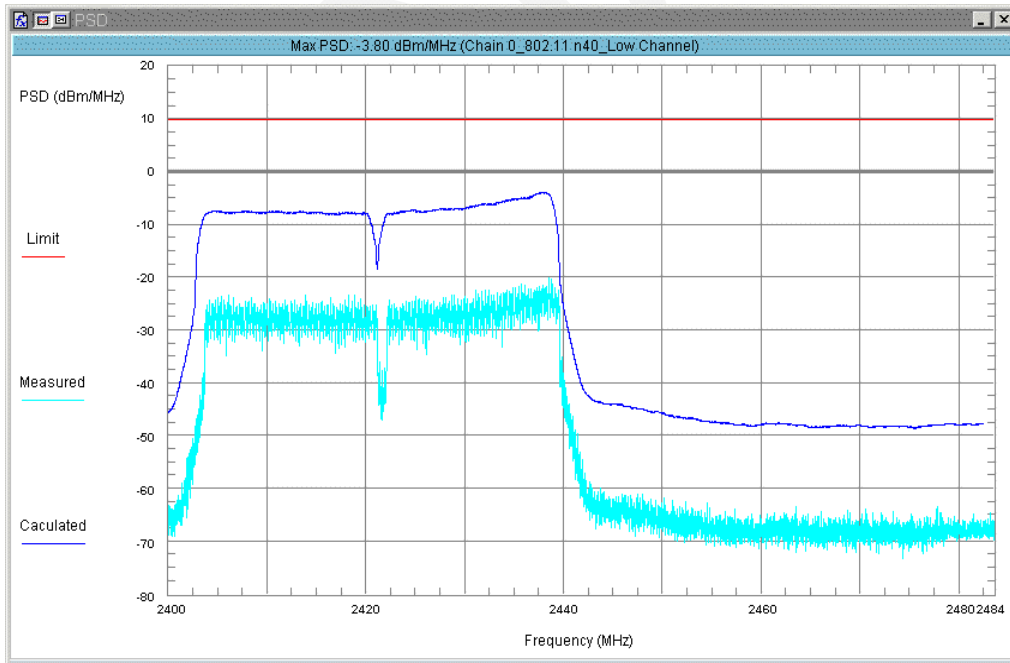

802.11n-HT40 Mode, Middle Channel: 2442 MHz

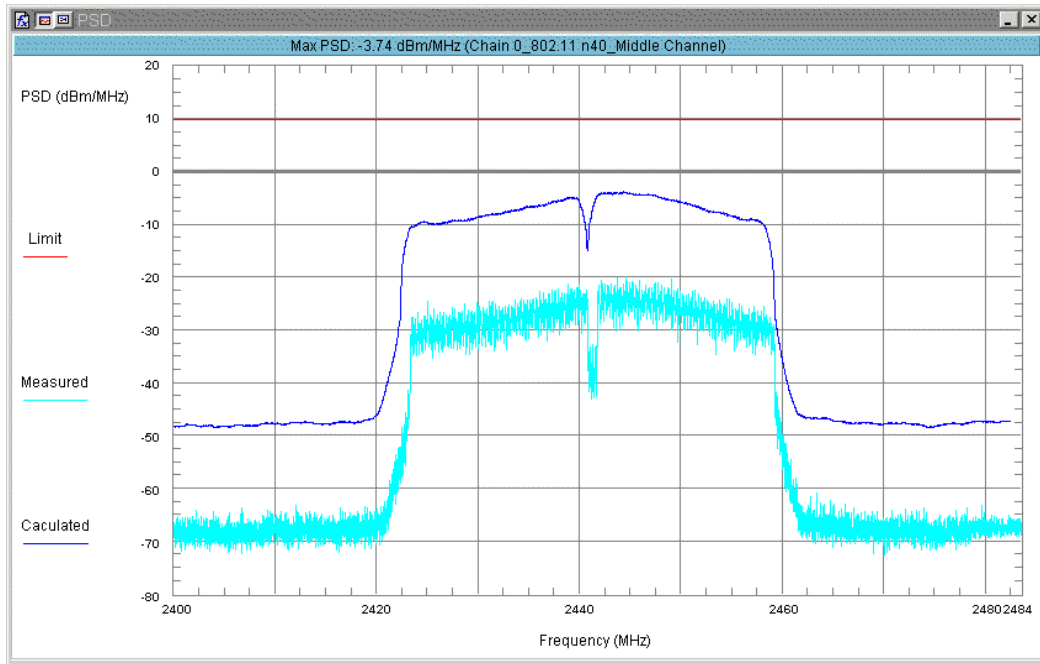

802.11n-HT40 Mode, High Channel: 2462 MHz

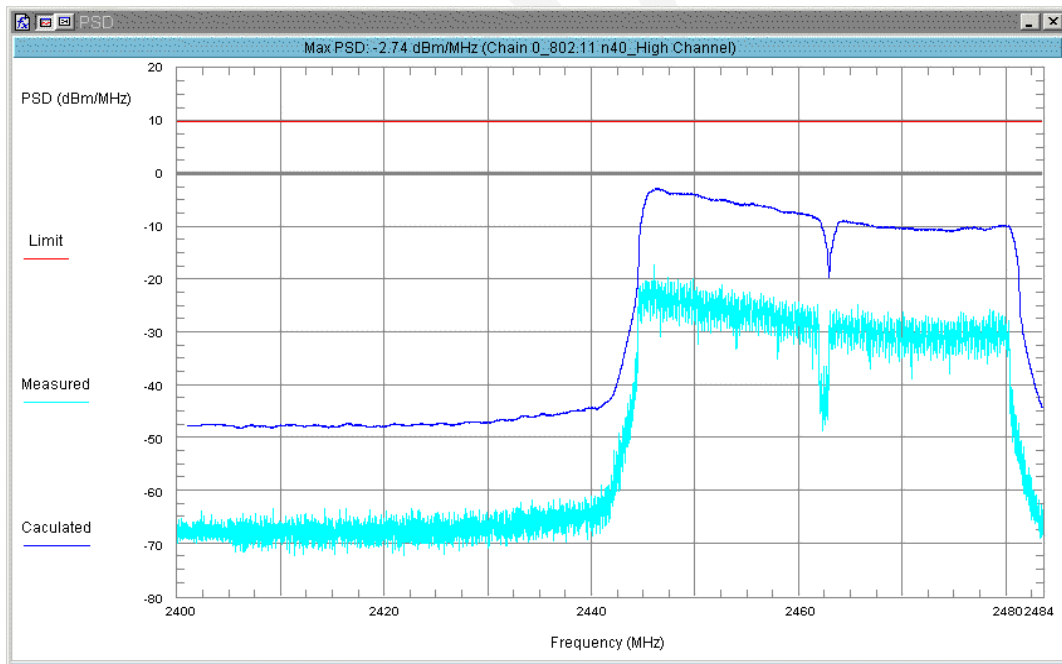

Note: The antenna gain was added into the final result.

ETSI EN 300 328 V2.1.1 (2016-11) §4.3.2.7 – OCCUPIED CHANNEL BANDWIDTH

Applicable Standard

According to ETSI EN 300 328 V2.1.1 (2016-11) §4.3.2.7.2, the occupied channel bandwidth is the bandwidth that contains 99 % of the power of the signal.

Limit:

The Occupied Channel Bandwidth shall fall completely within the band given in table 1.

In addition, for non-adaptive equipment using wide band modulations other than FHSS and with e.i.r.p. greater than 10 dBm, the occupied channel bandwidth shall be less than 20 MHz.

Test Procedure

The measurement procedure shall be as follows:

Step 1:

Connect the UUT to the spectrum analyser and use the following settings:

- Centre Frequency: The centre frequency of the channel under test
- Resolution BW: ~ 1 % of the span without going below 1 %
- Video BW: $3 \times \text{RBW}$
- Frequency Span: $2 \times \text{Nominal Channel Bandwidth}$
- Detector Mode: RMS
- Trace Mode: Max Hold
- Sweep time: 1 s

Step 2:

Wait for the trace to stabilize.

Find the peak value of the trace and place the analyser marker on this peak.

Step 3:

Use the 99 % bandwidth function of the spectrum analyser to measure the Occupied Channel Bandwidth of the UUT. This value shall be recorded.

NOTE: Make sure that the power envelope is sufficiently above the noise floor of the analyser to avoid the noise signals left and right from the power envelope being taken into account by this measurement.

Test Data**Environmental Conditions**

Temperature:	26 °C
Relative Humidity:	53 %
ATM Pressure:	101.0 kPa

The testing was performed by Dylan Li on 2017-05-01.

EUT operation mode: Transmitting

Test Result: Compliant, please refer to following table and plots.

Channel	Frequency (MHz)	Occupied Bandwidth (MHz)
802.11b		
Low	2412	14.359
High	2472	14.744
802.11g		
Low	2412	16.731
High	2472	16.795
802.11n-HT20		
Low	2412	17.885
High	2472	17.949
802.11n-HT40		
Low	2422	36.795
High	2462	36.667

802.11b, Low Channel

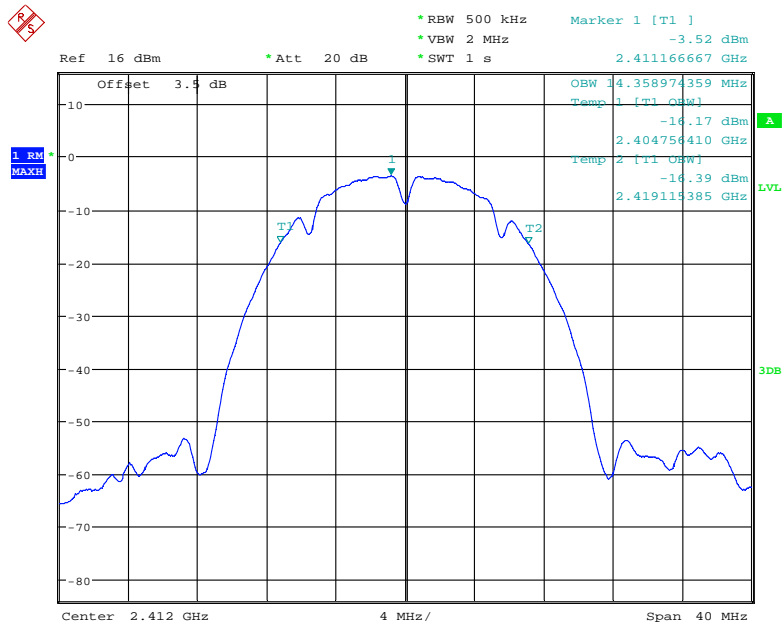

Date: 1.MAY.2017 10:57:13

802.11b, High Channel

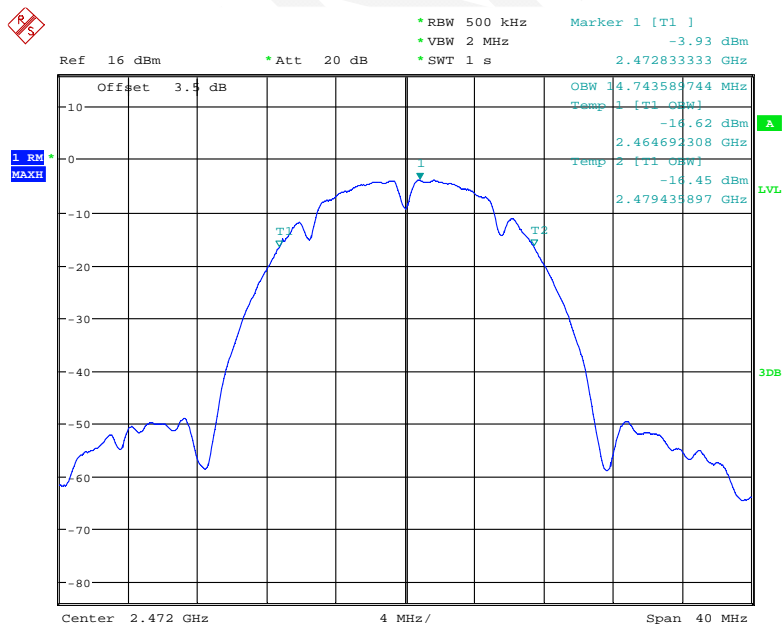

Date: 1.MAY.2017 10:57:43

802.11g, Low Channel

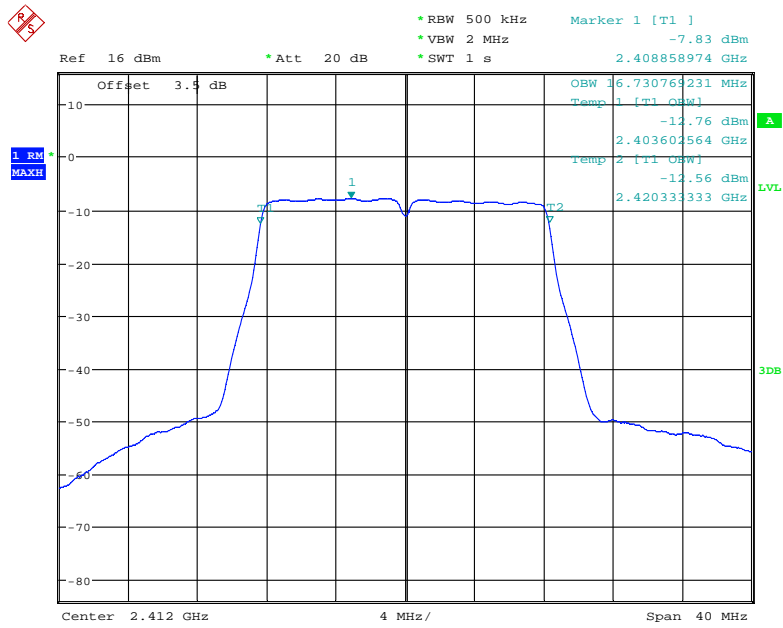

Date: 1.MAY.2017 10:55:54

802.11g, High Channel

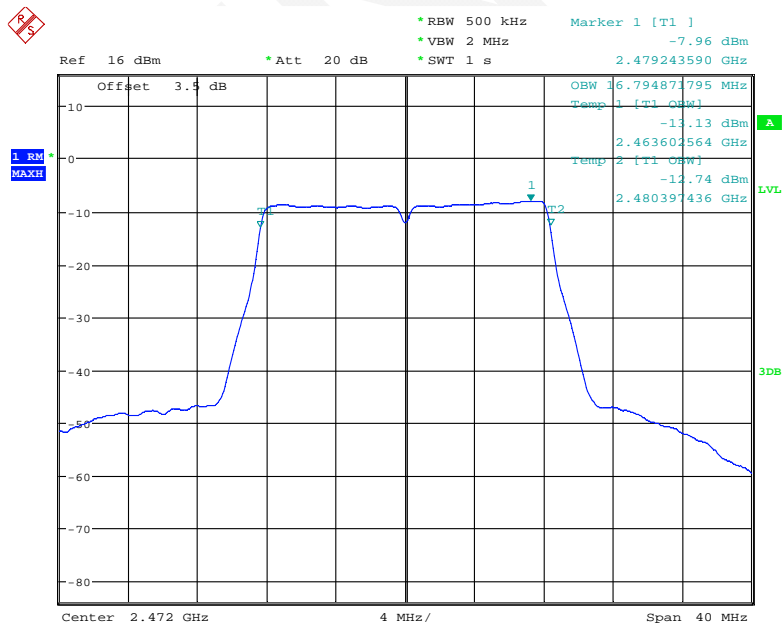

Date: 1.MAY.2017 10:56:24

802.11n-HT20, Low Channel

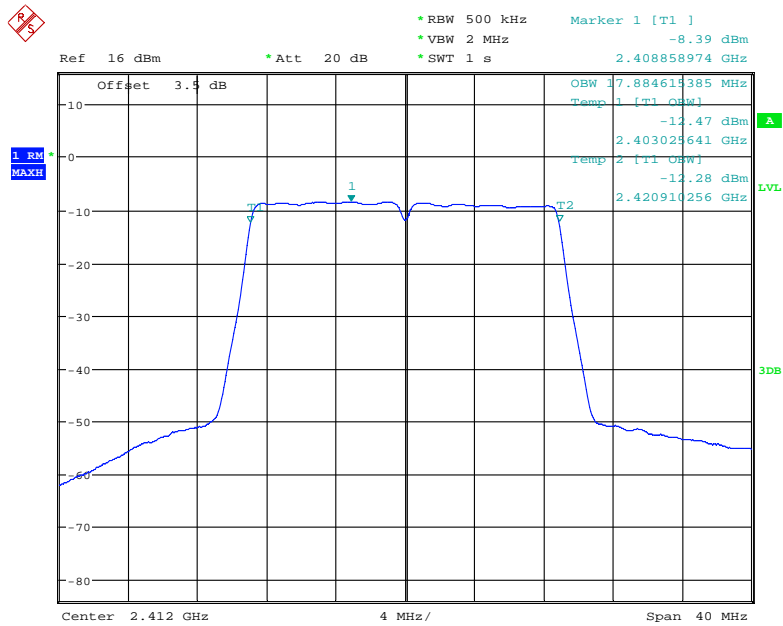

Date: 1.MAY.2017 10:55:06

802.11n-HT20, High Channel

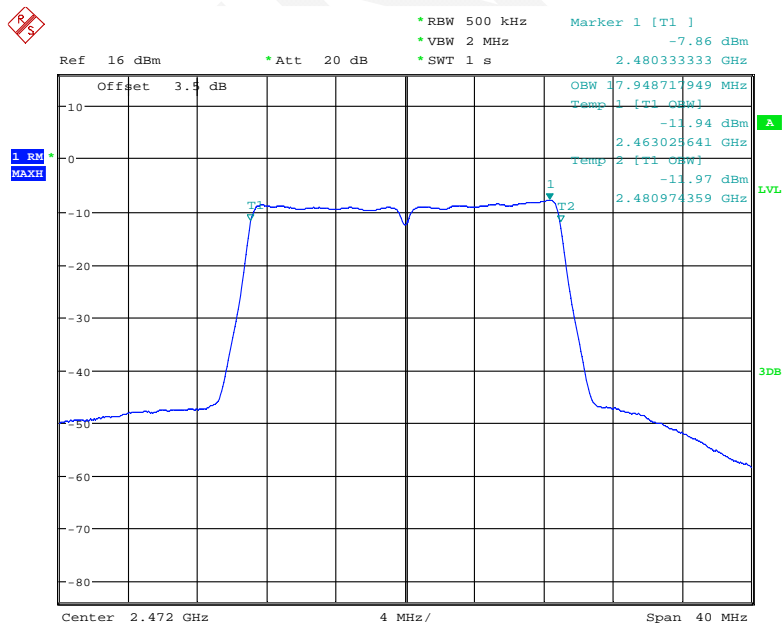

Date: 1.MAY.2017 10:55:32

802.11n-HT40, Low Channel

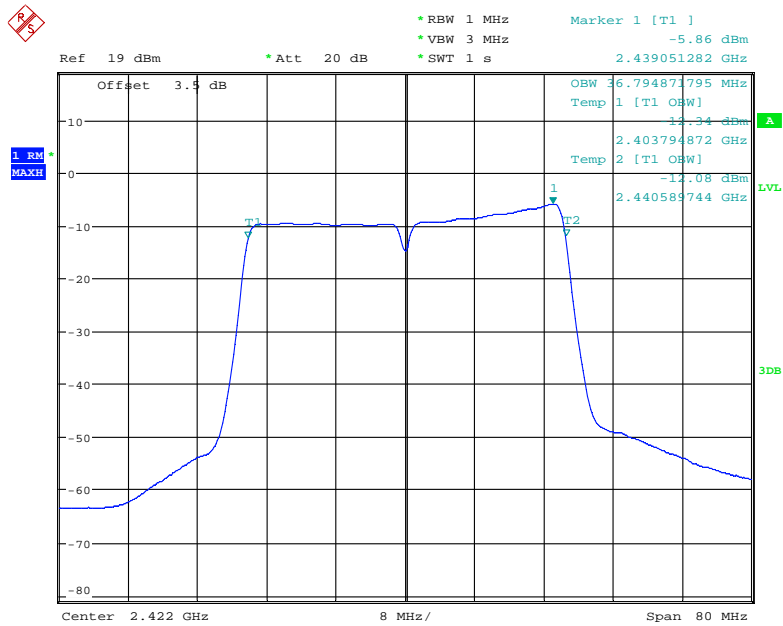

Date: 1.MAY.2017 10:54:04

802.11n-HT40, High Channel

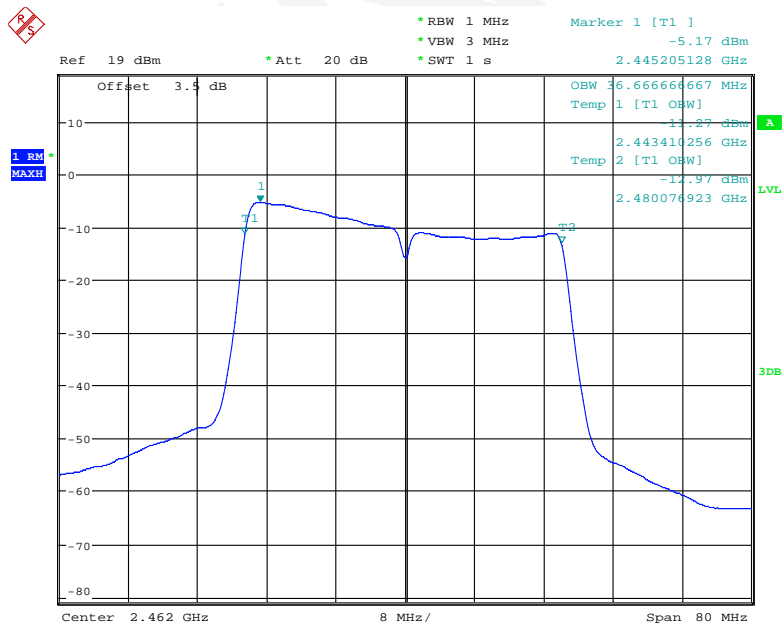

Date: 1.MAY.2017 10:53:13

ETSI EN 300 328 V2.1.1 (2016-11) §4.3.2.8 – TRANSMITTER UNWANTED EMISSION IN THE OUT-OF-BAND DOMAIN

Applicable Standard

According to ETSI EN 300 328 V2.1.1 (2016-11) §4.3.2.8.2, Transmitter unwanted emissions in the out-of-band domain are emissions when the equipment is in Transmit mode, on frequencies immediately outside the necessary bandwidth which results from the modulation process, but excluding spurious emissions.

Limit:

The transmitter unwanted emissions in the out-of-band domain but outside the allocated band, shall not exceed the values provided by the mask in figure 3.

NOTE: Within the band specified in table 1, the Out-of-band emissions are fulfilled by compliance with the Occupied Channel Bandwidth requirement in clause 4.3.2.7.

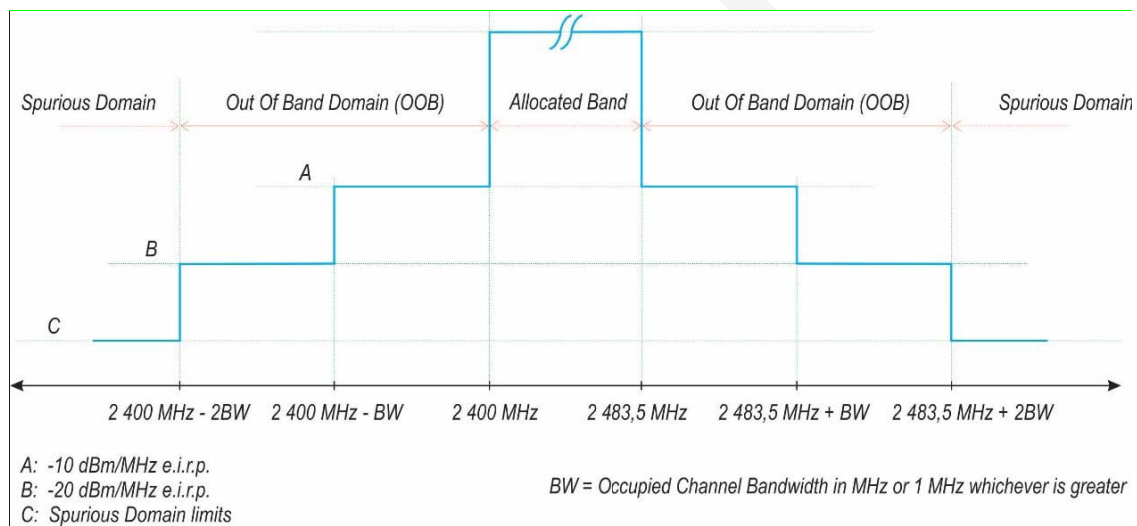

Test Procedure

According to ETSI EN 300 328 V2.1.1 (2016-11) §5.4.8.2

Test Data

Environmental Conditions

Temperature:	26 °C
Relative Humidity:	53 %
ATM Pressure:	101.0 kPa

The testing was performed by Dylan Li on 2017-05-01.

EUT operation mode: Transmitting

802.11b- Left Side

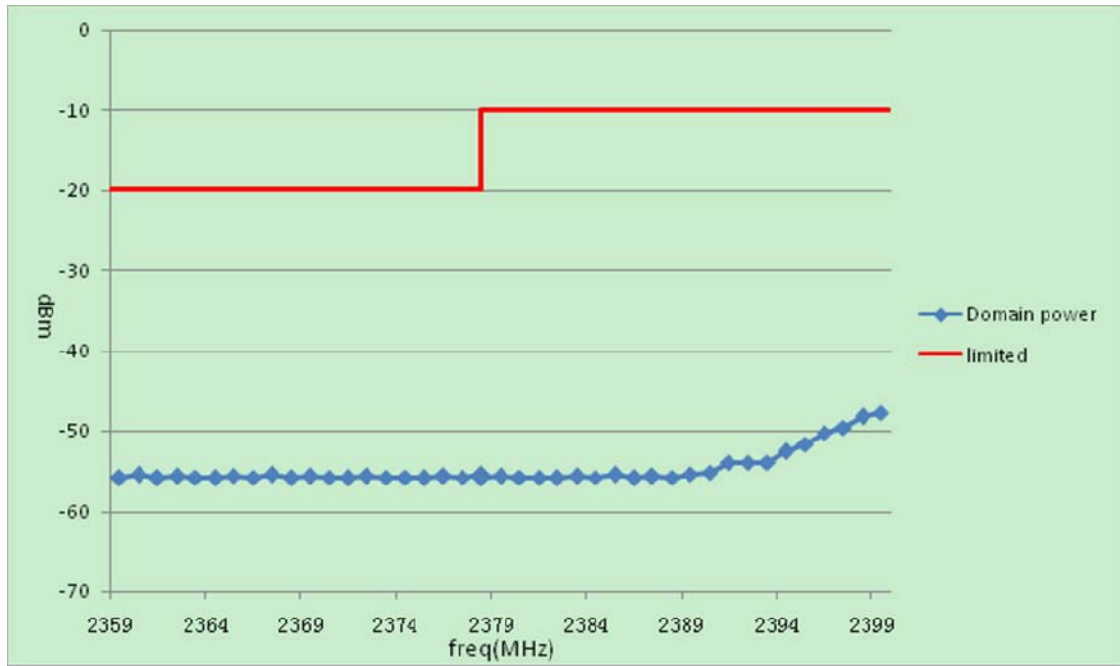

802.11b- Right Side

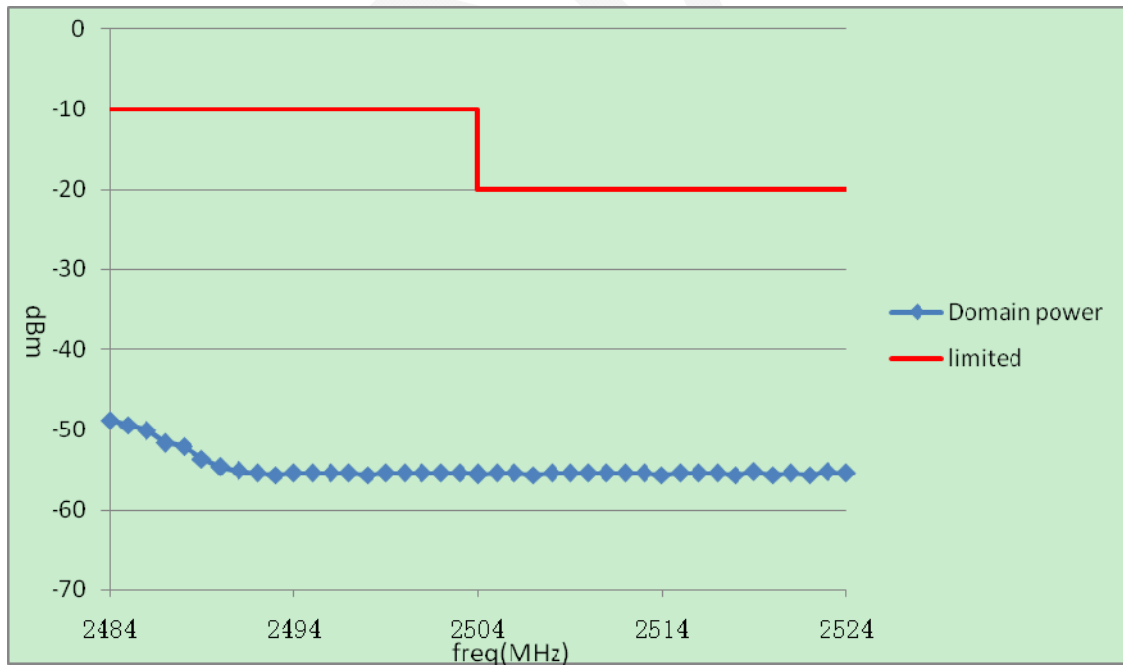

802.11g- Left Side

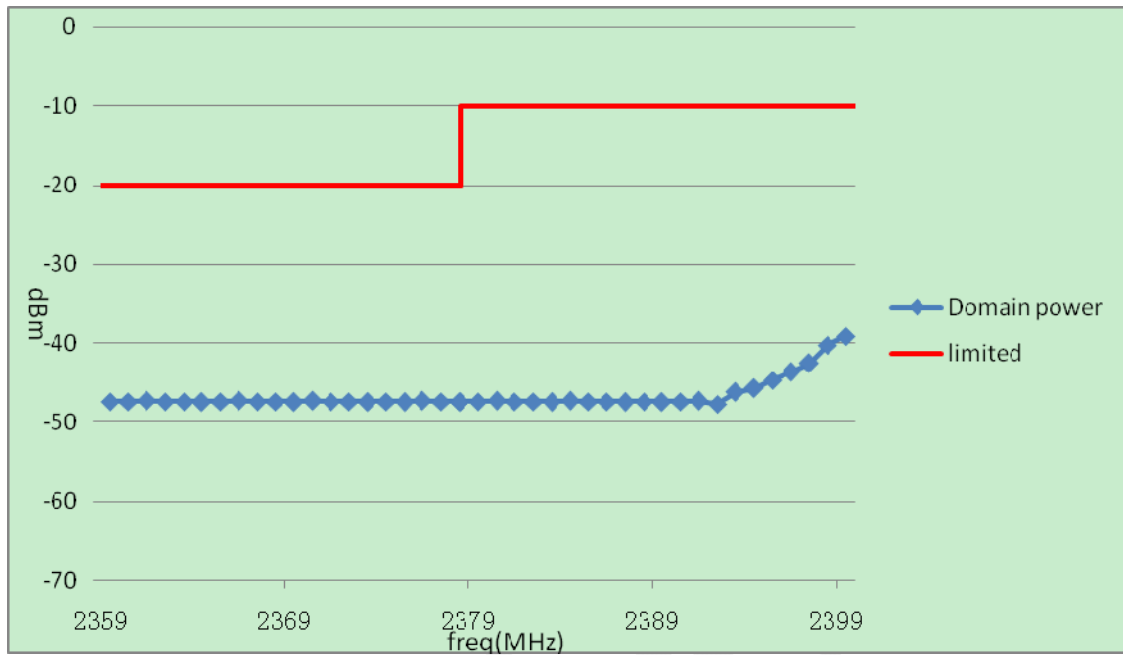

802.11g- Right Side

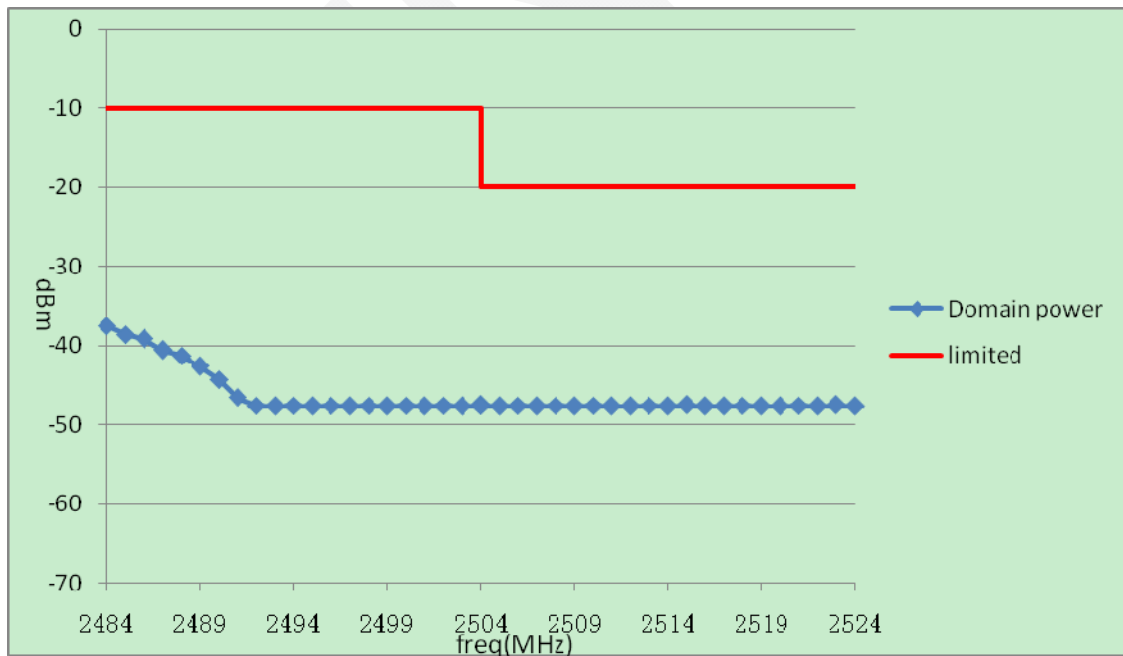

802.11n20- Left Side

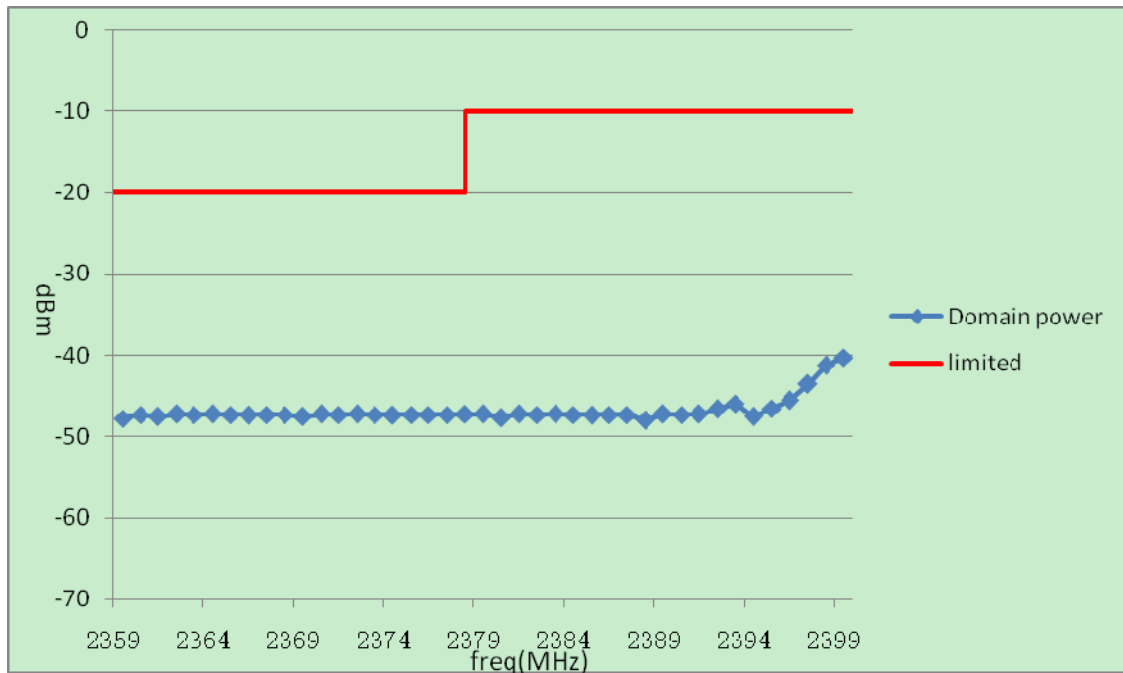

802.11n20- Right Side

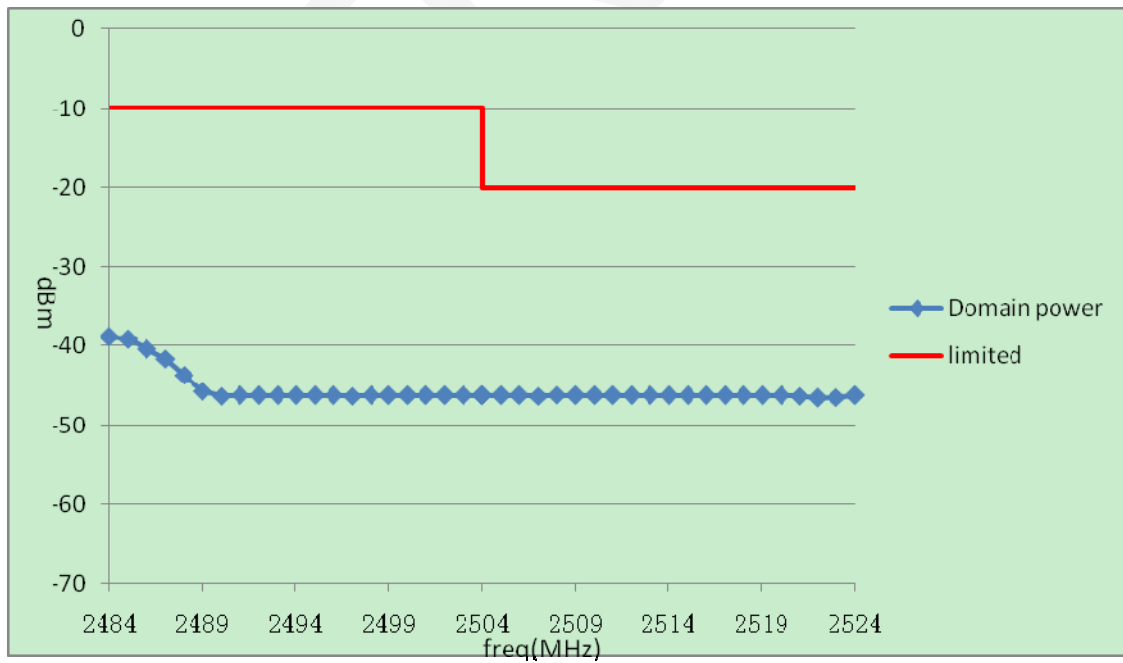

802.11n40- Left Side

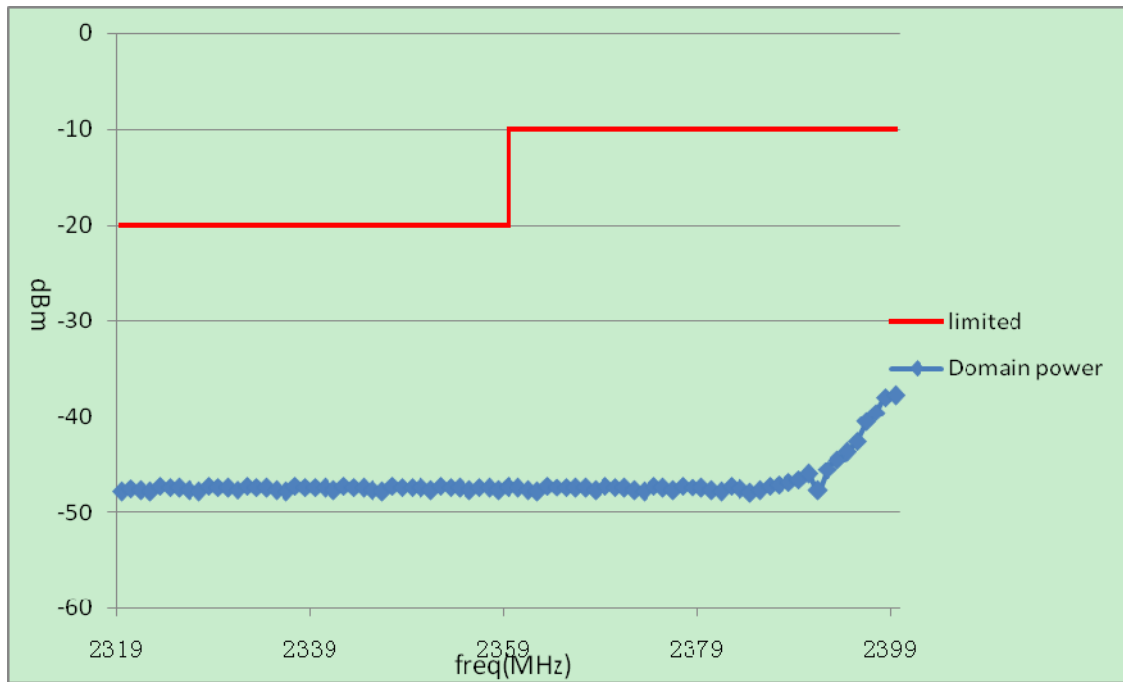

802.11n40- Right Side

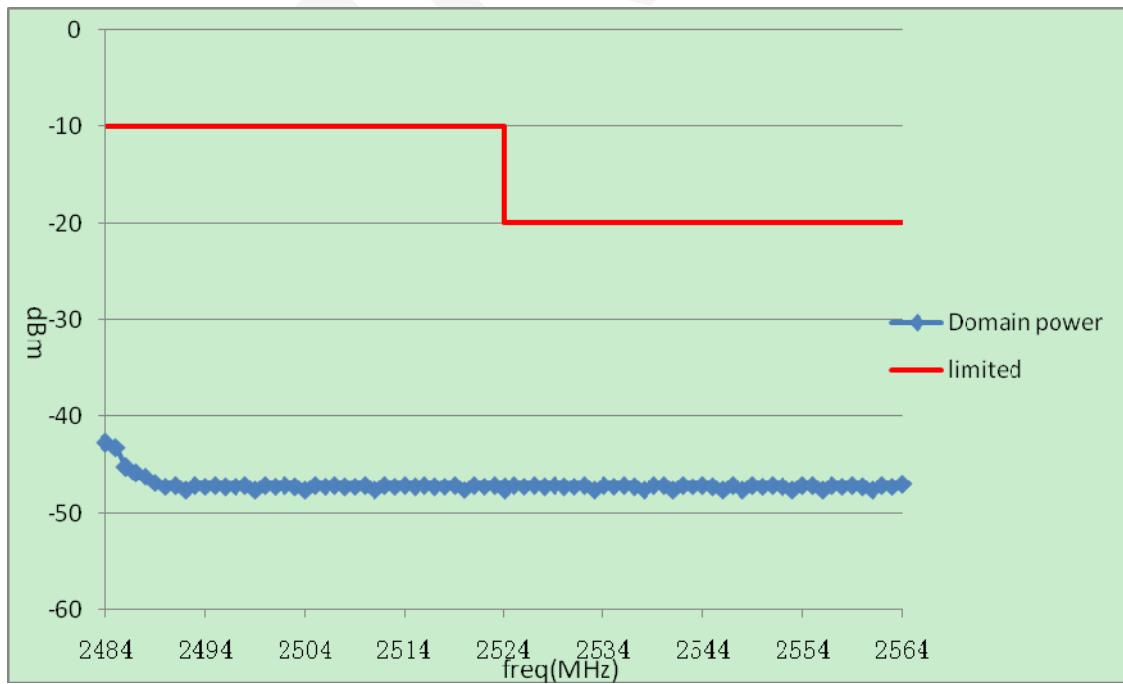

ETSI EN 300 328 V2.1.1 (2016-11) §4.3.2.9 – TRANSMITTER UNWANTED EMISSION IN THE SPURIOUS DOMAIN

Applicable Standard

Transmitter unwanted emissions in the spurious domain are emissions outside the allocated band and outside the Out-of-band Domain as indicated in figure 3 when the equipment is in Transmit mode.

The transmitter unwanted emissions in the spurious domain shall not exceed the values given in the following table.

Transmitter limits for spurious emissions

Frequency Range	Maximum power e.r.p (≤ 1 GHz) e.i.r.p (> 1 GHz)	Bandwidth
30 MHz to 47 MHz	-36 dBm	100 kHz
47 MHz to 74 MHz	-54 dBm	100 kHz
74 MHz to 87,5 MHz	-36 dBm	100 kHz
87,5 MHz to 118 MHz	-54 dBm	100 kHz
118 MHz to 174 MHz	-36 dBm	100 kHz
174 MHz to 230 MHz	-54 dBm	100 kHz
230 MHz to 470 MHz	-36 dBm	100 kHz
470 MHz to 862 MHz	-54 dBm	100 kHz
862 MHz to 1 GHz	-36 dBm	100 kHz
1 GHz to 12,75 GHz	-30 dBm	1MHz

NOTE: In case of equipment with antenna connectors, these limits apply to emissions at the antenna port (conducted). For emissions radiated by the cabinet or emissions radiated by integral antenna equipment (without antenna connectors), these limits are e.r.p. for emissions up to 1 GHz and as e.i.r.p. for emissions above 1 GHz.

Test Procedure

According to ETSI EN 300 328 V2.1.1 (2016-11) §5.4.9.2

Test Data

Environmental Conditions

Temperature:	26°C
Relative Humidity:	53 %
ATM Pressure:	101.0 kPa

The testing was performed by Dylan Li on 2017-05-01.

EUT operation mode: Transmitting

30 MHz ~ 12.75 GHz:

Frequency (MHz)	Receiver Reading (dBµV)	Turntable Angle Degree	Rx Antenna		Substituted			Absolute Level (dBm)	EN 300 328	
			Height (m)	Polar (H/V)	SG Level (dBm)	Cable Loss (dB)	Antenna Gain (dB)		Limit (dBm)	Margin (dB)
802.11b Low Channel										
264.32	33.14	258	1.7	H	-61.9	0.3	0.0	-62.2	-36	26.2
264.32	32.08	294	2.3	V	-62.9	0.3	0.0	-63.2	-36	27.2
4824.00	34.43	127	1.8	H	-56.5	1.60	11.20	-46.90	-30	16.90
4824.00	34.82	175	2.5	V	-55.3	1.60	11.20	-45.70	-30	15.70
802.11b High Channel										
264.32	33.24	74	1.1	H	-61.8	0.3	0.0	-62.1	-36	26.1
264.32	32.41	200	1.1	V	-62.6	0.3	0.0	-62.9	-36	26.9
4944.00	37.44	148	1.3	H	-53.0	1.60	11.10	-43.50	-30	13.50
4944.00	36.59	207	1.8	V	-53.5	1.60	11.10	-44.00	-30	14.00
802.11g Low Channel										
264.32	32.58	349	1.8	H	-62.4	0.3	0.0	-62.7	-36	26.7
264.32	31.67	329	1.1	V	-63.3	0.3	0.0	-63.6	-36	27.6
4824.00	33.84	52	1.4	H	-57.1	1.60	11.20	-47.50	-30	17.50
4824.00	33.87	110	2.4	V	-56.2	1.60	11.20	-46.60	-30	16.60
802.11g High Channel										
264.32	31.69	238	1.9	H	-63.3	0.3	0.0	-63.6	-36	27.6
264.32	30.78	260	1.7	V	-64.2	0.3	0.0	-64.5	-36	28.5
4944.00	36.14	320	1.7	H	-54.3	1.60	11.10	-44.80	-30	14.80
4944.00	35.28	9	2.3	V	-54.8	1.60	11.10	-45.30	-30	15.30

Frequency (MHz)	Receiver Reading (dBμV)	Turntable Angle Degree	Rx Antenna		Substituted			Absolute Level (dBm)	EN 300 328	
			Height (m)	Polar (H/V)	SG Level (dBm)	Cable Loss (dB)	Antenna Gain (dB)		Limit (dBm)	Margin (dB)
802.11n-HT20 Low Channel										
264.32	32.48	192	1.8	H	-62.5	0.3	0.0	-62.8	-36	26.8
264.32	31.54	8	1.5	V	-63.5	0.3	0.0	-63.8	-36	27.8
4824.00	34.53	101	2.2	H	-56.4	1.60	11.20	-46.80	-30	16.80
4824.00	34.97	37	2.1	V	-55.1	1.60	11.20	-45.50	-30	15.50
802.11n-HT20 High Channel										
264.32	32.04	174	1.8	H	-63.0	0.3	0.0	-63.3	-36	27.3
264.32	31.59	289	1.2	V	-63.4	0.3	0.0	-63.7	-36	27.7
4944.00	36.23	226	1.0	H	-54.2	1.60	11.10	-44.70	-30	14.70
4944.00	35.57	61	1.5	V	-54.5	1.60	11.10	-45.00	-30	15.00
802.11n-HT40 Low Channel										
264.32	32.38	43	1.8	H	-62.6	0.3	0.0	-62.9	-36	26.9
264.32	31.27	13	1.6	V	-63.7	0.3	0.0	-64.0	-36	28.0
4844.00	35.59	186	1.3	H	-55.3	1.60	11.20	-45.70	-30	15.70
4844.00	36.44	20	2.1	V	-53.6	1.60	11.20	-44.00	-30	14.00
802.11n-HT40 High Channel										
264.32	31.45	70	2.0	H	-63.6	0.3	0.0	-63.9	-36	27.9
264.32	30.89	233	1.6	V	-64.1	0.3	0.0	-64.4	-36	28.4
4924.00	36.15	6	1.9	H	-54.3	1.60	11.10	-44.80	-30	14.80
4924.00	35.43	29	2.0	V	-54.7	1.60	11.10	-45.20	-30	15.20

Note:

Absolute Level = SG Level - Cable loss + Antenna Gain

Margin = Limit- Absolute Level

ETSI EN 300 328 V2.1.1 (2016-11) §4.3.2.10 – RECEIVER SPURIOUS EMISSIONS

Applicable Standard

According to ETSI EN 300 328 V2.1.1 (2016-11) §4.3.2.10, the receiver spurious emissions are emissions at any frequency when the equipment is in receive mode.

The spurious emissions of the receiver shall not exceed the values given in the following table

Frequency range	Maximum power, e.r.p.	Measurement bandwidth
30 MHz to 1 GHz	-57 dBm	100 kHz
1 GHz to 12,75 GHz	-47 dBm	1 MHz

NOTE: In case of equipment with antenna connectors, these limits apply to emissions at the antenna port (conducted). For emissions radiated by the cabinet or for emissions radiated by integral antenna equipment (without antenna connectors), these limits are e.r.p. for emissions up to 1 GHz and e.i.r.p. for emissions above 1 GHz.

Test Procedure

According to ETSI EN 300 328 V2.1.1 (2016-11) §5.4.10.2.1

Test Data

Environmental Conditions

Temperature:	26 °C
Relative Humidity:	53 %
ATM Pressure:	101.0 kPa

The testing was performed by Dylan Li on 2017-05-01.

EUT operation mode: Receiving (Worst case)

30 MHz ~ 12.75 GHz:

Frequency (MHz)	Receiver Reading (dBμV)	Turntable Angle Degree	Rx Antenna		Substituted			Absolute Level (dBm)	EN 300 328	
			Height (m)	Polar (H/V)	SG Level (dBm)	Cable Loss (dB)	Antenna Gain (dB)		Limit (dBm)	Margin (dB)
802.11b Low Channel										
187.88	31.04	136	2.3	H	-64.0	0.3	0.0	-64.3	-57	7.30
187.88	30.56	39	2.3	V	-64.4	0.3	0.0	-64.7	-57	7.70
1154.45	31.27	84	1.8	H	-66.9	1.50	7.20	-61.20	-47	14.20
1154.45	30.42	156	1.8	V	-67.6	1.50	7.20	-61.90	-47	14.90
802.11b High Channel										
187.88	31.23	54	2.4	H	-63.8	0.3	0.0	-64.1	-57	7.10
187.88	29.77	134	1.3	V	-65.2	0.3	0.0	-65.5	-57	8.50
1154.45	31.37	294	1.7	H	-66.8	1.50	7.20	-61.10	-47	14.10
1154.45	30.17	283	2.3	V	-67.9	1.50	7.20	-62.20	-47	15.20

Note:

Absolute Level = SG Level - Cable loss + Antenna Gain

Margin = Limit- Absolute Level

ETSI EN 300 328 V2.1.1 (2016-11) §4.3.2.11 - RECEIVER BLOCKING**Applicable Standard**

This requirement applies to all receiver categories as defined in clause 4.2.3.

Limit:

The minimum performance criterion shall be a PER less than or equal to 10 %. The manufacturer may declare alternative performance criteria as long as that is appropriate for the intended use of the equipment (see clause 5.4.1.t)).

While maintaining the minimum performance criteria as defined in clause 4.3.2.11.3, the blocking levels at specified frequency offsets shall be equal to or greater than the limits defined for the applicable receiver category provided in table 14, table 15 or table 16.

Table 14: Receiver Blocking parameters for Receiver Category 1 equipment

Wanted signal mean power from companion device (dBm)	Blocking signal frequency (MHz)	Blocking signal power (dBm) (see note 2)	Type of blocking signal
$P_{\min} + 6$ dB	2 380 2 503,5	-53	CW
$P_{\min} + 6$ dB	2 300 2 330 2 360	-47	CW
$P_{\min} + 6$ dB	2 523,5 2 553,5 2 583,5 2 613,5 2 643,5 2 673,5	-47	CW
NOTE 1: P_{\min} is the minimum level of the wanted signal (in dBm) required to meet the minimum performance criteria as defined in clause 4.3.2.11.3 in the absence of any blocking signal.			
NOTE 2: The levels specified are levels in front of the UUT antenna. In case of conducted measurements, the levels have to be corrected by the actual antenna assembly gain.			

Table 15: Receiver Blocking parameters receiver category 2 equipment

Wanted signal mean power from companion device (dBm)	Blocking signal frequency (MHz)	Blocking signal power (dBm) (see note 2)	Type of blocking signal
$P_{\min} + 6$ dB	2 380 2 503,5	-57	CW
$P_{\min} + 6$ dB	2 300 2 583,5	-47	CW
NOTE 1: P_{\min} is the minimum level of the wanted signal (in dBm) required to meet the minimum performance criteria as defined in clause 4.3.2.11.3 in the absence of any blocking signal.			
NOTE 2: The levels specified are levels in front of the UUT antenna. In case of conducted measurements, the levels have to be corrected by the actual antenna assembly gain.			

Table 16: Receiver Blocking parameters receiver category 3 equipment

Wanted signal mean power from companion device (dBm)	Blocking signal frequency (MHz)	Blocking signal power (dBm) (see note 2)	Type of blocking signal
$P_{min} + 12$ dB	2 380 2 503,5	-57	CW
$P_{min} + 12$ dB	2 300 2 583,5	-47	CW

NOTE 1: P_{min} is the minimum level of the wanted signal (in dBm) required to meet the minimum performance criteria as defined in clause 4.3.2.11.3 in the absence of any blocking signal.

NOTE 2: The levels specified are levels in front of the UUT antenna. In case of conducted measurements, the levels have to be corrected by the actual antenna assembly gain.

Test Procedure

Conducted measurement:

For systems using multiple receive chains only one chain (antenna port) need to be tested. All other receiver inputs shall be terminated.

Figure 6 shows the test set-up which can be used for performing the receiver blocking test.

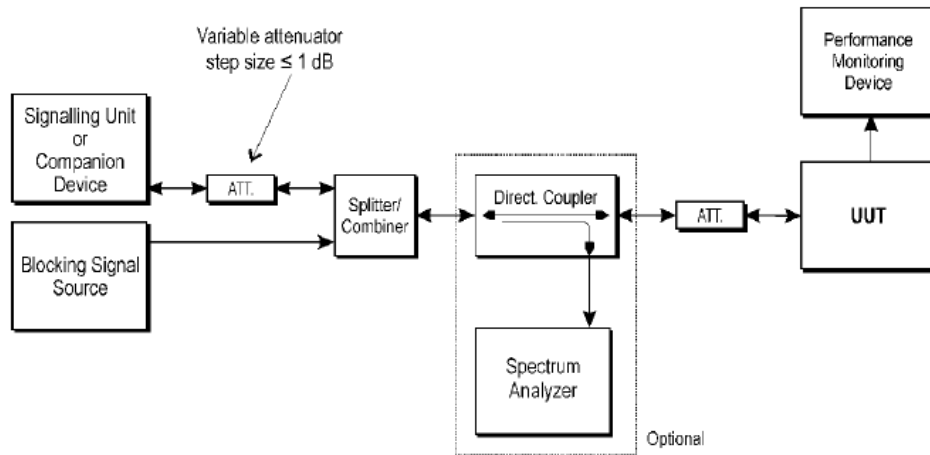

Figure 6: Test Set-up for receiver blocking

The procedure in step 1 to step 6 below shall be used to verify the receiver blocking requirement as described in clause 4.3.1.12 or clause 4.3.2.11.

Table 6, table 7 and table 8 in clause 4.3.1.12.4 contain the applicable blocking frequencies and blocking levels for each of the receiver categories for testing Receiver Blocking on frequency hopping equipment.

Table 14, table 15 and table 16 in clause 4.3.2.11.4 contain the applicable blocking frequencies and blocking levels for each of the receiver categories for testing Receiver Blocking on equipment using wide band modulations other than FHSS.

Step 1:

- For non-frequency hopping equipment, the UUT shall be set to the lowest operating channel.

Step 2:

- The blocking signal generator is set to the first frequency as defined in the appropriate table corresponding to the receiver category and type of equipment.

Step 3:

- With the blocking signal generator switched off, a communication link is established between the UUT and the associated companion device using the test setup shown in figure 6. The attenuation of the variable attenuator shall be increased in 1 dB steps to a value at which the minimum performance criteria as specified in clause 4.3.1.12.3 or clause 4.3.2.11.3 is still met. The resulting level for the wanted signal at the input of the UUT is Pmin.
- This signal level (Pmin) is increased by the value provided in the table corresponding to the receiver category and type of equipment.

Step 4:

- The blocking signal at the UUT is set to the level provided in the table corresponding to the receiver category and type of equipment. It shall be verified and recorded in the test report that the performance criteria as specified in clause 4.3.1.12.3 or clause 4.3.2.11.3 is met.

Step 5:

- Repeat step 4 for each remaining combination of frequency and level for the blocking signal as provided in the table corresponding to the receiver category and type of equipment.

Step 6:

- For non-frequency hopping equipment, repeat step 2 to step 5 with the UUT operating at the highest operating channel.

Test Data

Environmental Conditions

Temperature:	26°C
Relative Humidity:	53 %
ATM Pressure:	101.0 kPa

The testing was performed by Dylan Li on 2017-05-01.

EUT operation mode: Receiving (Worst Case)

The Maximum EIRP is 9.05dBm<10dBm and the EUT is an adaptive device, so it belongs to the receiver category 2.

Mode	Blocking Signal Frequency (MHz)	Type Of Blocking Signal	PER (%)	Limit (%)
Normal Operation (802.11b - Low Channel)	2380	CW	5	≤10
	2503.5	CW	5	
	2300	CW	5	
	2583.5	CW	5	
Normal Operation (802.11b - High Channel)	2380	CW	5	
	2503.5	CW	5	
	2300	CW	5	
	2583.5	CW	5	

Test Result: Compliance

**EXHIBIT A - E.2 INFORMATION AS REQUIRED BY EN 300 328 V2.1.1,
CLAUSE 5.4.1**

In accordance with EN 300 328, clause 5.4.1, the following information is provided by the supplier.

a) The type of modulation used by the equipment:

- FHSS
 other forms of modulation

b) In case of FHSS modulation:

In case of non-Adaptive Frequency Hopping equipment:

The number of Hopping Frequencies: _____.

In case of Adaptive Frequency Hopping Equipment:

The maximum number of Hopping Frequencies: _____;

The minimum number of Hopping Frequencies: _____;

The Accumulated Transmit Time: _____;

The Minimum Channel Occupation Time: _____;

c) Adaptive / non-adaptive equipment:

- non-adaptive Equipment
 adaptive Equipment without the possibility to switch to a non-adaptive mode
 adaptive Equipment which can also operate in a non-adaptive mode

d) In case of adaptive equipment:

The Channel Occupancy Time implemented by the equipment: ____ms

- The equipment has implemented an LBT based DAA mechanism

In case of equipment using modulation different from FHSS:

- The equipment is Frame Based equipment
 The equipment is Load Based equipment
 The equipment can switch dynamically between Frame Based and Load Based equipment

The CCA time implemented by the equipment: ____ μ s

- The equipment has implemented a non-LBT based DAA mechanism
 The equipment can operate in more than one adaptive mode

e) In case of non-adaptive Equipment:

The maximum RF Output Power (e.i.r.p.): _____dBm

The maximum (corresponding) Duty Cycle: _____%

Equipment with dynamic behaviour, that behaviour is described here. (e.g. the different combinations of duty cycle and corresponding power levels to be declared):
_____.

f) The worst case operational mode for each of the following tests:

RF Output Power: 9.05dBm ;
 Power Spectral Density 0.49dBm/MHz ;
 Duty cycle, Tx-Sequence, Tx-gap N/A ;
 Accumulated Transmit Time, Minimum Frequency Occupation & Hopping Sequence (only for FHSS equipment)
N/A ;
 Hopping Frequency Separation (only for FHSS equipment) N/A ;
 Medium Utilisation N/A ;
 Adaptivity N/A ;
 Receiver Blocking Pass ;
 Occupied Channel Bandwidth 36.795MHz ;
 Transmitter unwanted emissions in the OOB domain -37.47dBm/MHz ;
 Transmitter unwanted emissions in the spurious domain -43.50dBm ;
 Receiver spurious emissions -64.10dBm ;

g) The different transmit operating modes (tick all that apply):

- Operating mode 1: Single Antenna Equipment
 Equipment with only 1 antenna
 Equipment with 2 diversity antennas but only 1 antenna active at any moment in time
 Smart Antenna Systems with 2 or more antennas, but operating in a (legacy) mode where only 1 antenna is used.
 (e.g. IEEE 802.11™ [i.3] legacy mode in smart antenna systems)
- Operating mode 2: Smart Antenna Systems - Multiple Antennas without beam forming
 Single spatial stream / Standard throughput / (e.g. IEEE 802.11™ [i.3] legacy mode)
 High Throughput (> 1 spatial stream) using Occupied Channel Bandwidth 1
 High Throughput (> 1 spatial stream) using Occupied Channel Bandwidth 2
 Note: Add more lines if more channel bandwidths are supported.
- Operating mode 3: Smart Antenna Systems - Multiple Antennas with beam forming
 Single spatial stream / Standard throughput (e.g. IEEE 802.11™ [i.3] legacy mode)
 High Throughput (> 1 spatial stream) using Occupied Channel Bandwidth 1
 High Throughput (> 1 spatial stream) using Occupied Channel Bandwidth 2
 Note: Add more lines if more channel bandwidths are supported.

h) In case of Smart Antenna Systems:

The number of Receive chains: _____ ;
 The number of Transmit chains: _____ ;

- symmetrical power distribution
 asymmetrical power distribution

In case of beam forming, the maximum beam forming gain: N/A ;

Note: Beam forming gain does not include the basic gain of a single antenna.

i) Operating Frequency Range(s) of the equipment:

Operating Frequency Range 1: 2412 MHz to 2472 MHz
 Operating Frequency Range 2: 2422 MHz to 2462 MHz

Note: Add more lines if more Frequency Ranges are supported.

j) Nominal Channel Bandwidth(s):

Occupied Channel Bandwidth 1: 802.11 b Mode 14.744 MHz
Occupied Channel Bandwidth 2: 802.11 g Mode 16.795 MHz
Occupied Channel Bandwidth 3: 802.11 N20 Mode 17.949 MHz
Occupied Channel Bandwidth 4: 802.11 N40 Mode 36.795 MHz

Note: Add more lines if more channel bandwidths are supported.

k) Type of Equipment (stand-alone, combined, plug-in radio device, etc.):

- Stand-alone
 Combined Equipment (Equipment where the radio part is fully integrated within another type of equipment)
 Plug-in radio device (Equipment intended for a variety of host systems)
 Other _____;

l) The normal and the extreme operating conditions that apply to the equipment:**Normal operating conditions (if applicable):**

Operating temperature range: +25 °C
Other (please specify if applicable): _____

Extreme operating conditions:

Operating temperature range: Minimum: -20 °C Maximum +55 °C
Other (please specify if applicable): _____ Minimum: _____ Maximum _____

Details provided are for the: stand-alone equipment
 combined (or host) equipment
 test jig

m) The intended combination(s) of the radio equipment power settings and one or more antenna assemblies and their corresponding e.i.r.p levels:

Antenna Type:

- Integral Antenna (information to be provided in case of conducted measurements)

Antenna Gain: 0.5 dBi

If applicable, additional beamforming gain (excluding basic antenna gain): _____ dB

- Temporary RF connector provided
 No temporary RF connector provided
- Dedicated Antennas (equipment with antenna connector)
 Single power level with corresponding antenna(s)
 Multiple power settings and corresponding antenna(s)

Number of different Power Levels: _____;
Power Level 1: _____ dBm
Power Level 2: _____ dBm
Power Level 3: _____ dBm

Note 1: Add more lines in case the equipment has more power levels.

Note 2: These power levels are conducted power levels (at antenna connector).

For each of the Power Levels, provide the intended antenna assemblies, their corresponding gains (G) and the resulting e.i.r.p. levels also taking into account the beamforming gain (Y) if applicable

Power Level 1: _____ dBm

Number of antenna assemblies provided for this power level:

Assembly #	Gain (dBi)	e.i.r.p. (dBm)	Part number or model name
1			
2			
3			
4			

Note 3: Add more rows in case more antenna assemblies are supported for this power level.

Power Level 2: _____ dBm

Number of antenna assemblies provided for this power level:

Assembly #	Gain (dBi)	e.i.r.p. (dBm)	Part number or model name
1			
2			
3			
4			

Note 4: Add more rows in case more antenna assemblies are supported for this power level.

Power Level 2: _____ dBm

Number of antenna assemblies provided for this power level:

Assembly #	Gain (dBi)	e.i.r.p. (dBm)	Part number or model name
1			
2			
3			
4			

Note 5: Add more rows in case more antenna assemblies are supported for this power level.

n) The nominal voltages of the stand-alone radio equipment or the nominal voltages of the combined (host) equipment or test jig in case of plug-in devices:

Details provided are for the: stand-alone equipment
 combined (or host) equipment
 test jig

Supply Voltage AC mains State AC voltage _____V
 DC State DC voltage 3.7 V

In case of DC, indicate the type of power source

- Internal Power Supply
 External Power Supply or AC/DC adapter
 Battery
 Other: _____.

o) Describe the test modes available which can facilitate testing:

The measurements shall be performed during continuously transmitting.

p) The equipment type (e.g. Bluetooth®, IEEE 802.11™ [i.3], proprietary, etc.):

IEEE 802.11™ [i.3].

q) If applicable, the statistical analysis referred to in clause 5.3.1 q)

(to be provided as separate attachment)

r) If applicable, the statistical analysis referred to in clause 5.3.1 r)

(to be provided as separate attachment)

s) Geo-location capability supported by the equipment:

Yes

The geographical location determined by the equipment as defined in clause 4.3.1.13.2 or clause 4.3.2.12.2 is not accessible to the user.

No

t) Describe the minimum performance criteria that apply to the equipment (see clause 4.3.1.12.3 or clause 4.3.2.11.3): N/A.

EXHIBIT B - EUT PHOTOGRAPHS

EUT – All View



EUT – Front View



EUT – Rear View



EUT – Top View



EUT – Bottom View



EUT – Left View



EUT – Right View



EUT – Cover off View 1



EUT – Cover off View 2



EUT – Cover off View 3



EUT – Cover off View 4



EUT – Main Board Top View

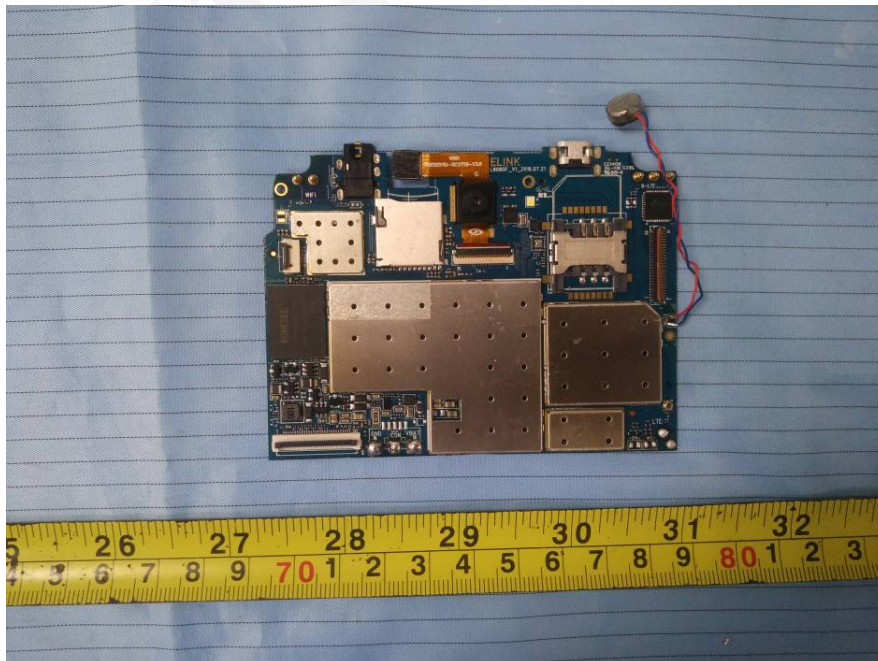

EUT – Main Board Top Shielding off View

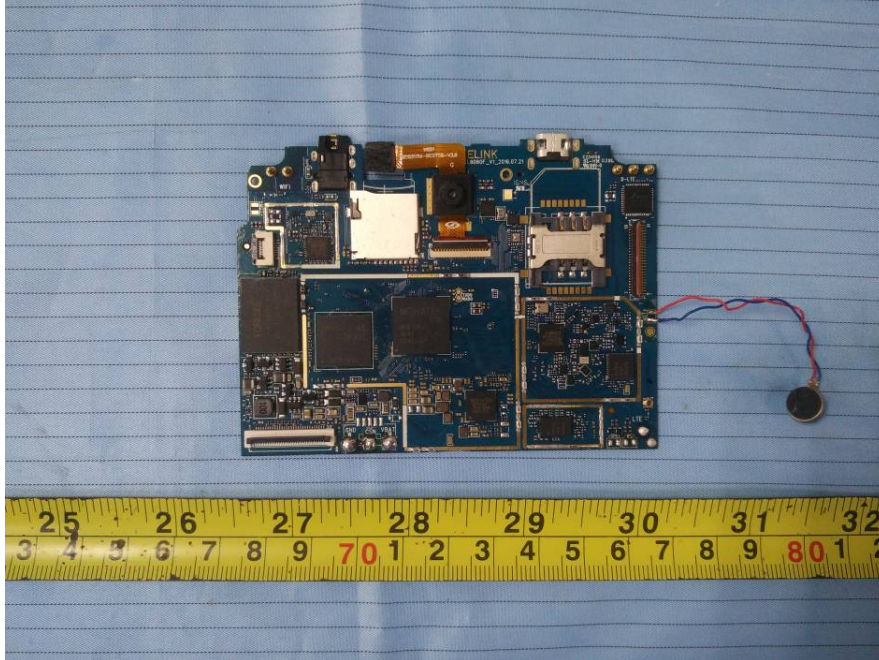

EUT –Main Board Bottom View

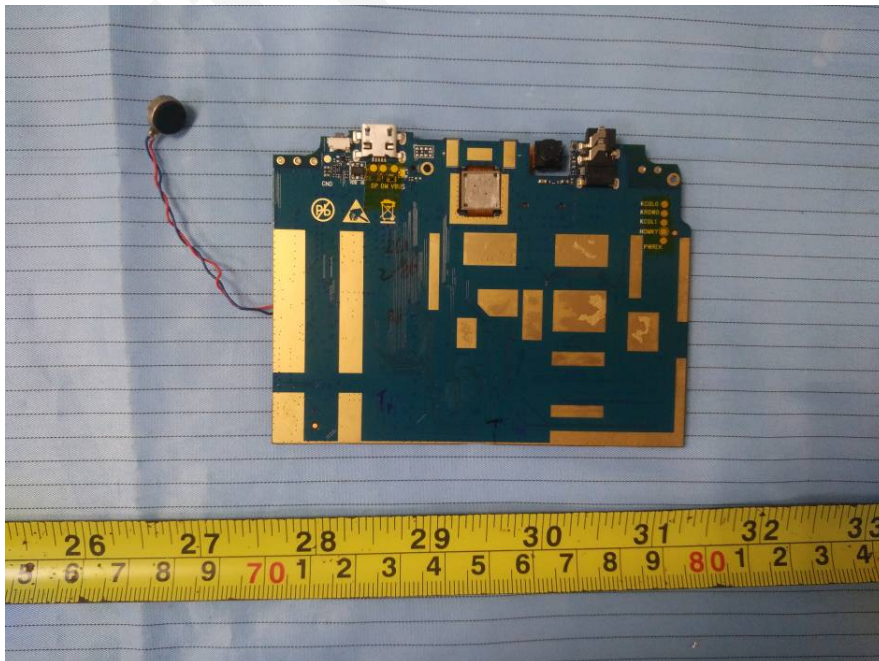

EUT – IC Chip View

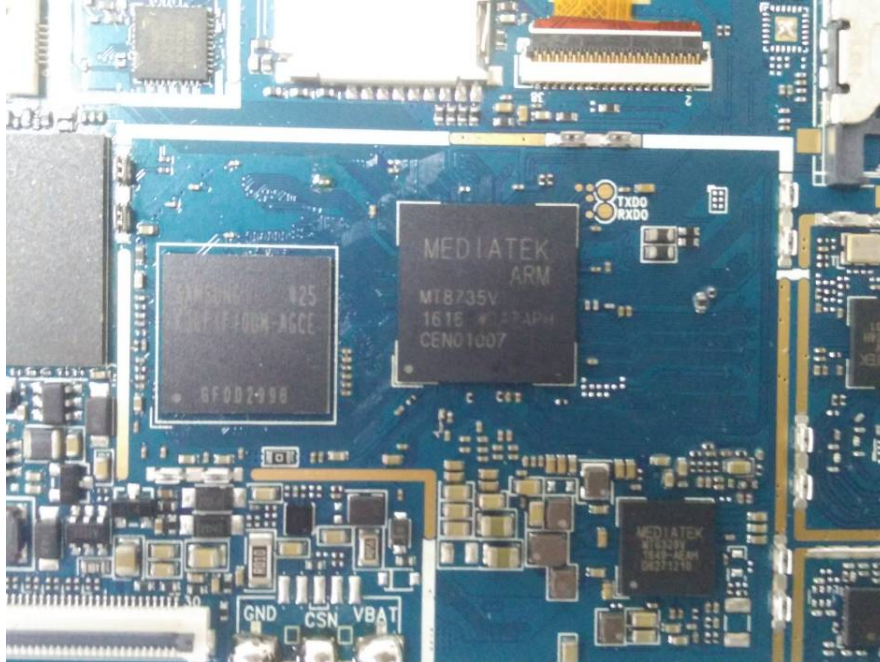

EUT – Adapter View



EUT – Adapter Label View



EUT – Battery Front View

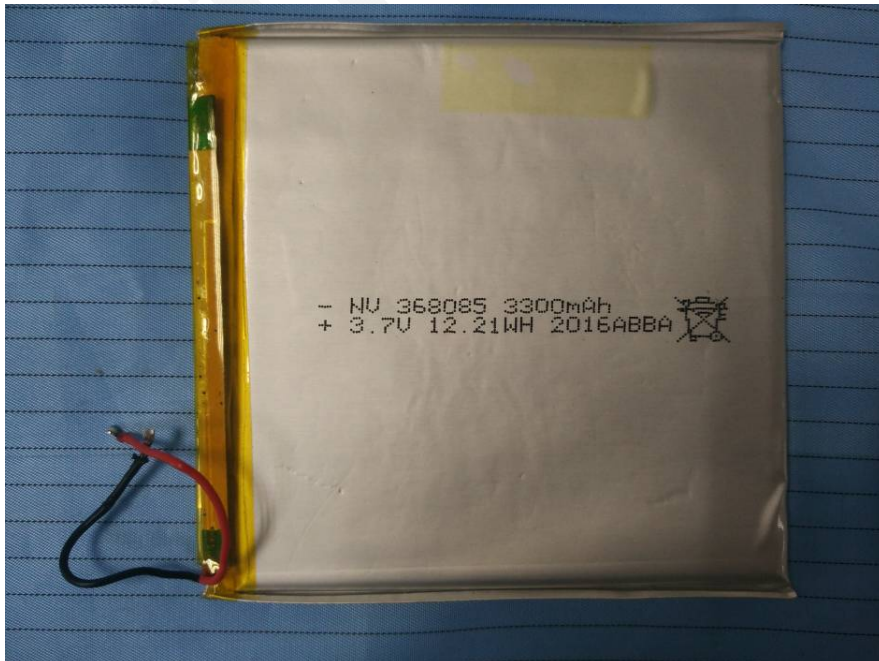

EUT – Battery Rear View



EXHIBIT C - TEST SETUP PHOTOGRAPHS

Radiated Spurious Emissions Test View (Below 1GHz)



Radiated Spurious Emissions Test View (Above 1GHz)



******* END OF REPORT *******