

EMC Test Report

For

Vonino Electronics (HK) Limited

LED Batten Tube lights

Model No.: LED-V40-L15, LED-V41-L15, SL-LPT-1.2M, SL-LPT-0.9M, SL-LPT-0.6M

Prepared For : Vonino Electronics (HK) Limited

Address : #1109, 11/F, Kowloon Center 33 Ashley Road
Tsim Sha Tsui, Kowloon, Hong Kong

Prepared By : Shenzhen Anbotek Compliance Laboratory Limited

Address : 1/F, Building D, Sogood Science and Technology Park, Sanwei
community, Hangcheng Street, Bao'an District, Shenzhen, Guangdong,
China.518102

Tel: (86) 755-26066440 Fax: (86) 755-26014772

Report Number : R0117090004E

Date of Test : Mar. 20~Apr. 02, 2018

Date of Report : Apr. 02, 2018

Contents

1. General Information.....	5
1.1. Client Information.....	5
1.2. Description of Device (EUT).....	5
1.3. Auxiliary Equipment Used During Test.....	5
1.4. Description of Test Mode.....	6
1.5. Test Summary.....	6
1.6. Test Equipment List.....	7
1.7. Measurement Uncertainty.....	9
1.8. Description of Test Facility.....	9
1.9. EMS Performance Criteria.....	9
2. Power Line Conducted Emission Test.....	10
2.1. Test Standard and Limit.....	10
2.2. Test Setup.....	10
2.3. EUT Configuration on Measurement.....	10
2.4. Operating Condition of EUT.....	10
2.5. Test Procedure.....	11
2.6. Test Results.....	11
3. Radiated Emission Test.....	14
3.1. Test Standard and Limit.....	14
3.2. Test Setup.....	14
3.3. EUT Configuration on Measurement.....	14
3.4. Operating Condition of EUT.....	15
3.5. Test Procedure.....	15
3.6. Test Results.....	15
4. Magnetic Radiated Emission Test.....	18
4.1. Test Standard and Limit.....	18
4.2. Test Setup.....	18
4.3. EUT Configuration on Measurement.....	18
4.4. Operating Condition of EUT.....	18
4.5. Test Procedure.....	19
4.6. Test Results.....	19
5. Harmonic Current Emission Test.....	23
5.1. Test Standard.....	23
5.2. Test Setup.....	23
5.3. Operating Condition of EUT.....	23
5.4. Test Results.....	23
6. Voltage Fluctuations & Flicker Test.....	26
6.1. Test Standard.....	26
6.2. Test Setup.....	26
6.3. Operating Condition of EUT.....	26
6.4. Test Results.....	26
7. Electrostatic Discharge Immunity Test.....	28
7.1. Test Standard and Level.....	28

7.2. Test Setup.....	28
7.3. EUT Configuration on Measurement.....	28
7.4. Operating Condition of EUT.....	28
7.5. Test Procedure.....	29
7.6. Test Results.....	29
8. RF Field Strength Susceptibility Test.....	31
8.1. Test Standard and Level.....	31
8.2. Test Setup.....	31
8.3. EUT Configuration on Measurement.....	31
8.4. Operating Condition of EUT.....	32
8.5. Test Procedure.....	32
8.6. Measuring Results.....	32
9. Electrical Fast Transient/Burst Immunity Test.....	34
9.1. Test Standard and Level.....	34
9.2. Test Setup.....	34
9.3. EUT Configuration on Measurement.....	34
9.4. Operating Condition of EUT.....	34
9.5. Test Procedure.....	35
9.6. Test Results.....	35
10. Surge Immunity Test.....	37
10.1. Test Standard and Level.....	37
10.2. Test Setup.....	37
10.3. EUT Configuration on Measurement.....	37
10.4. Operating Condition of EUT.....	37
10.5. Test Procedure.....	38
10.6. Test Results.....	38
11. Injected Currents Susceptibility Test.....	40
11.1. Test Standard and Level.....	40
11.2. Test Setup.....	40
11.3. EUT Configuration.....	40
11.4. Operating Condition of EUT.....	40
11.5. Test Procedure.....	41
11.6. Test Results.....	41
12. Voltage Dips And Interruptions Test.....	43
12.1. Test Standard and Level.....	43
12.2. Test Setup.....	43
12.3. EUT Configuration on Measurement.....	43
12.4. Operating Condition of EUT.....	43
12.5. Test Procedure.....	44
12.6. Test Results.....	44
APPENDIX I -- TEST SETUP PHOTOGRAPH.....	46
APPENDIX II -- EXTERNAL PHOTOGRAPH.....	51
APPENDIX III -- INTERNAL PHOTOGRAPH.....	52

TEST REPORT

Applicant : Vonino Electronics (HK) Limited
Manufacturer : Vonino Electronics (HK) Limited
Product Name : LED Batten Tube lights
Model No. : LED-V40-L15, LED-V41-L15, SL-LPT-1.2M, SL-LPT-0.9M, SL-LPT-0.6M
Trade Mark : N.A.
Rating(s) : AC85-265V, 50/60Hz
SL-LPT-1.2M(36W), SL-LPT-0.9M(28W), SL-LPT-0.6M(18W)

**Test Standard(s) : EN 55015: 2013+A1: 2015;
EN 61000-3-2: 2014;
EN 61000-3-3: 2013;
EN 61547: 2009;
(IEC 61000-4-2; IEC 61000-4-3; IEC 61000-4-4;
IEC 61000-4-5; IEC 61000-4-6; IEC 61000-4-11)**

The device described above is tested by Shenzhen Anbotek Compliance Laboratory Limited to determine the maximum emission levels emanating from the device and the severe levels of the device can endure and its performance criterion. The measurement results are contained in this test report and Shenzhen Anbotek Compliance Laboratory Limited is assumed full responsibility for the accuracy and completeness of these measurements. Also, this report shows that the EUT to be technically compliant with the EN 55015, EN 61000-3-2, EN 61000-3-3 and EN 61547 requirements. The Project in IEC 61000-4-3 was tested in Shenzhen EMTEK Co., Ltd.

This report applies to above tested sample only and shall not be reproduced in part without written approval of Shenzhen Anbotek Compliance Laboratory Limited.

Date of Test: Mar. 20~Apr. 02, 2018

Prepared By:

(Tested Engineer / Barc

Reviewer:

(Project Manager / Lu

Approved & Authorized Signer:

(Manager / Tom Chen)

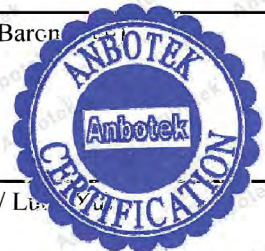

1. General Information

1.1. Client Information

Applicant	:	Vonino Electronics (HK) Limited
Address	:	#1109, 11/F, Kowloon Center 33 Ashley Road Tsim Sha Tsui, Kowloon, Hong Kong
Manufacturer	:	Vonino Electronics (HK) Limited
Address	:	#1109, 11/F, Kowloon Center 33 Ashley Road Tsim Sha Tsui, Kowloon, Hong Kong
Factory	:	Vonino Electronics (HK) Limited
Address	:	#1109, 11/F, Kowloon Center 33 Ashley Road Tsim Sha Tsui, Kowloon, Hong Kong

1.2. Description of Device (EUT)

Product Name	:	LED Batten Tube lights	
Model No.	:	LED-V40-L15, LED-V41-L15, SL-LPT-1.2M, SL-LPT-0.9M, SL-LPT-0.6M (Note: All samples are the same except the model number & appearance, so we prepare “SL-LPT-1.2M” for EMC test only.)	
Trade Mark	:	N.A.	
Test Power Supply	:	AC 230V, 50Hz	
Product Description	:	Adapter:	N/A
Remark: (1) For a more detailed features description, please refer to the manufacturer’s specifications or the User’s Manual.			

1.3. Auxiliary Equipment Used During Test

N/A	
-----	--

1.4. Description of Test Mode

Pretest Mode	Description
Mode 1	On

For Mode 1 Block Diagram of Test Setup

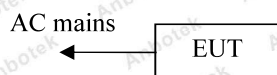

1.5. Test Summary

Test Items	Test Mode	Status
Power Line Conducted Emission Test (9KHz To 30MHz)	Mode 1	P
Radiated Emission Test (30MHz To 300MHz)	Mode 1	P
Magnetic Radiated Emission Test (9KHz To 30MHz)	Mode 1	P
Harmonic Current Test	Mode 1	P
Voltage Fluctuations and Flicker Test	Mode 1	P
Electrostatic Discharge immunity Test	Mode 1	P
RF Field Strength susceptibility Test	Mode 1	P
Electrical Fast Transient/Burst Immunity Test	Mode 1	P
Surge Immunity Test	Mode 1	P
Injected Currents Susceptibility Test	Mode 1	P
Voltage Dips and Interruptions Test	Mode 1	P
P) Indicates that the through the test. N) Don't test.		

1.6. Test Equipment List

Conducted Emission Measurement

Item	Equipment	Manufacturer	Model No.	Serial No.	Last Cal.	Cal. Interval
1.	L.I.S.N. Artificial Mains Network	Rohde & Schwarz	ENV216	100055	Nov. 17, 2017	1 Year
2.	EMI Test Receiver	Rohde & Schwarz	ESCI	100627	Nov. 17, 2017	1 Year
3.	RF Switching Unit	Compliance Direction	RSU-M2	38303	Nov. 17, 2017	1 Year
4.	Software Name EZ-EMC	Ferrari Technology	ANB-03A	N/A	N/A	N/A

Radiated Emission Measurement

Item	Equipment	Manufacturer	Model No.	Serial No.	Last Cal.	Cal. Interval
1.	EMI Test Receiver	Rohde & Schwarz	ESCI	100627	Nov. 17, 2017	1 Year
2.	Bilog Broadband Antenna	Schwarzbeck	VULB9163	VULB 9163-289	Nov. 20, 2017	1 Year
3.	Pre-amplifier	SONOMA	310N	186860	Nov. 17, 2017	1 Year
4.	Software Name EZ-EMC	Ferrari Technology	ANB-03A	N/A	N/A	N/A

Magnetic Radiated Emission Measurement

Item	Equipment	Manufacturer	Model No.	Serial No.	Last Cal.	Cal. Interval
1.	EMI Test Receiver	Rohde & Schwarz	ESCI	100627	Nov. 17, 2017	1 Year
2.	Triple-Loop Antenna(2M)	EVERFINE	LLA-2	905003	Nov. 17, 2017	1 Year
3.	RF Switching Unit	Compliance Direction	RSU-M2	38303	Nov. 17, 2017	1 Year
4.	Software Name EZ-EMC	Ferrari Technology	ANB-03A	N/A	N/A	N/A

Harmonic and Flicker Measurement

Item	Equipment	Manufacturer	Model No.	Serial No.	Last Cal.	Cal. Interval
1.	Programmable AC Power source	SOPH POWER	PAG-1050	630250	Nov. 17, 2017	1 Year
2.	Harmonic and Flicker Analyzer	EMC-PARTNER	HRRMOINCS -1000-1P	164	Apr. 07, 2017	1 Year
3.	Harmonics-1000	N/A	Ed.3.0+4.0	N.A	N/A	N/A

Electrostatic Discharge Measurement

Item	Equipment	Manufacturer	Model No.	Serial No.	Last Cal.	Cal. Interval
1.	ESD Simulators	3Ctest	ESD-30T	ES0131505	Nov. 17, 2017	1 Year

R/S Immunity Measurement

Item	Equipment	Manufacturer	Model No.	Serial No.	Last Cal.	Cal. Interval
1	RF Power Meter. Dual Channel	BOONTON	4232A	10539	May 20, 2017	1 year
2	50ohm Diode Power Sensor	BOONTON	51011EMC	34236/36164	May 20, 2017	1 year
3	Broad-Band Horn Antenna	SCHWARZBECK	BBHA9120 L3F	332	May 20, 2017	1 year
4	Power Amplifier (0.08-1G)	MILMEGA	80RF1000-175	1059345	May 20, 2017	1 year
5	Power Amplifier (1-2G)	MILMEGA	AS0102-55	1018770	May 20, 2017	1 year
6	Power Amplifier (2-6G)	MILMEGA	AS1860-50	1059346	May 20, 2017	1 year
7	Signal Generator	Agilent	N5181A	MY50145187	May 20, 2017	1 year
8	Field Strength Meter	HOLADAY	HI-6005	N/A	May 20, 2017	1 year
9	RS232 Fiber Optic Modem	HOLADAY	HI-4413P	N/A	May 20, 2017	1 year
10	Log.-Per. Antenna	SCHWARZBECK	VULP 9118E	N/A	May 20, 2017	1 year

Electrical Fast Transient/Burst Immunity Measurement

Item	Equipment	Manufacturer	Model No.	Serial No.	Last Cal.	Cal. Interval
1.1	EFT Burst Simulator	PRIMA	EFT61004B	PR10114282	Nov. 17, 2017	1 Year
1.2	EFT-Clamp	PRIMA	EFT-Clamp	/	Nov. 17, 2017	1 Year
2.1	EFT Burst Simulator	TESEQ	NSG 3060	1480	Nov. 17, 2017	1 Year
2.2	CDN	TESEQ	CDN 3061	1408	Nov. 17, 2017	1 Year

Surge Measurement

Item	Equipment	Manufacturer	Model No.	Serial No.	Last Cal.	Cal. Interval
1.1	6kV Surge Generator	TESEQ	NSG 3060	1480	Nov. 17, 2017	1 Year
1.2	CDN	TESEQ	CDN 3061	1408	Nov. 17, 2017	1 Year
2.1	6kV Surge Generator	EMPEK	LSG-5060G	06010017N	Nov. 17, 2017	1 Year
2.2	CDN	EMPEK	CDN-5110G	061100005N	Nov. 17, 2017	1 Year

Injected Currents Susceptibility Measurement

Item	Equipment	Manufacturer	Model No.	Serial No.	Last Cal.	Cal. Interval
1.	C/S Conducted Immunity Test System	FRANKONIA	CIT-10	126A1196/2012	Nov. 17, 2017	1 Year
2.	CDN	FRANKONIA	CDN - M2+ M3	A2210178/2012	Nov. 17, 2017	1 Year
3.	6dB Attenuator	FRANKONIA	DAM 26W	1172202	Nov. 17, 2017	1 Year
4.	CIT-10	FRANKONIA	Version 1.1.7	N/A	N.A	N/A

Voltage Dips and Interruptions Measurement

Item	Equipment	Manufacturer	Model No.	Serial No.	Last Cal.	Cal. Interval
1.	CYCLE SAG Simulator	PRIMA	DRP61011AG	PR12046234	Nov. 17, 2017	1 Year

1.7. Measurement Uncertainty

Radiation Uncertainty	:	Ur = 3.9 dB (Horizontal)
		Ur = 3.8 dB (Vertical)
Conduction Uncertainty	:	Uc = 3.4dB
Disturbance Uncertainty	:	Ud = 2.6 dB

1.8. Description of Test Facility

The test facility is recognized, certified, or accredited by the following organizations:

FCC-Registration No.: 184111

Shenzhen Anbotek Compliance Laboratory Limited, EMC Laboratory has been Registered and fully described in a report filed with the (FCC) Federal Communications Commission. The acceptance letter from the FCC is maintained in our files. Registration No. 184111, July 31, 2017.

ISED-Registration No.: 8058A-1

Shenzhen Anbotek Compliance Laboratory Limited, EMC Laboratory has been registered and fully described in a report filed with the (ISED) Innovation, Science and Economic Development Canada. The acceptance letter from the ISED is maintained in our files. Registration 8058A-1, June 13, 2016.

Test Location

All Emissions tests were performed at Shenzhen Anbotek Compliance Laboratory Limited.

1/F, Building D, Sogood Science and Technology Park, Sanwei community, Hangcheng Street, Bao'an District, Shenzhen, Guangdong, China.518102

1.9. EMS Performance Criteria

- √ A: Normal performance within the specification limits
- √ B: Temporary degradation or loss of function or performance which is self-recoverable
- √ C: Temporary degradation or loss of function or performance which requires operator intervention or system reset
- √ D: Degradation or loss of function which is not recoverable due to damage of equipment (components) or software, or loss of data

Note: The manufacturer's specification may define effects on the EUT which may be considered insignificant, and therefore acceptable.

This classification may be used as a guide in formulating performance criteria, by committees responsible for generic, product and product-family standards, or as a framework for the agreement on performance criteria between the manufacturer and the purchaser, for example where no suitable generic, product or product-family standard exists.

2. Power Line Conducted Emission Test

2.1. Test Standard and Limit

Test Standard	EN 55015
---------------	----------

Limits for conducted emissions

Test Limit	Frequency	At mains terminals (dB μ V)	
		Quasi-peak Level	Average Level
	9kHz ~ 50kHz	110	--
	50kHz ~ 150kHz	90 ~ 80*	--
	150kHz ~ 0.5MHz	66 ~ 56*	56 ~ 46*
	0.5MHz ~ 5.0MHz	56	46
	5.0MHz ~ 30MHz	60	50

Remark: (1) At the transition frequency the lower limit applies.
(2) * decreasing linearly with logarithm of the frequency.

2.2. Test Setup

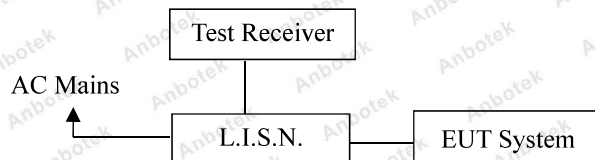

2.3. EUT Configuration on Measurement

The following equipments are installed on Conducted Emission Measurement to meet EN 55015 requirements and operating in a manner which tends to maximize its emission characteristics in a normal application.

2.4. Operating Condition of EUT

- 2.4.1. Setup the EUT as shown in Section 2.2.
- 2.4.2. Turn on the power of all equipments.
- 2.4.3. Let the EUT work in test mode and measure it.

2.5. Test Procedure

The EUT is put on the table which is 0.8 meter high above the ground and connected to the AC mains through a Line Impedance Stabilization Network (L.I.S.N.). This provided a 50ohm coupling impedance for the tested equipments. Both sides of AC line are checked to find out the maximum conducted emission according to the EN 55015 regulations during conducted emission measurement. And the voltage probe had been used for the load terminals measurement according to the EN 55015 standard.

The bandwidth of the test receiver (R&S ESCI) is set at 200Hz in 9K~150KHz range and 9KHz in 150K~30MHz range.

The frequency range from 9KHz to 30MHz is checked.

All the test results are listed in Section 2.6.

2.6. Test Results

PASS

The test curves are shown in the following pages.

Conducted Emission Test Data

Test Site: 1# Shielded Room
 Test Specification: AC 230V, 50Hz
 Comment: Live Line
 Temp.: 22.2°C Hum.: 60%

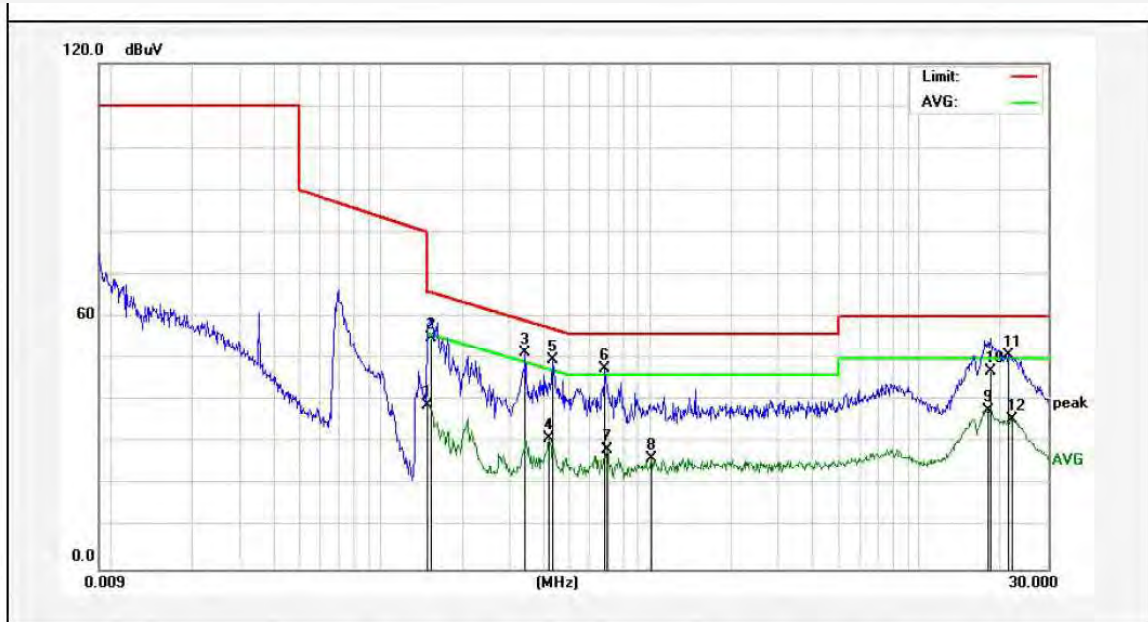

No.	Freq. (MHz)	Reading (dBuV)	Factor (dB)	Result (dBuV)	Limit dBuV	Over Limit (dB)	Detector	Remark
1	0.1500	18.96	19.90	38.86	55.99	-17.13	AVG	
2	0.1539	35.18	19.90	55.08	65.78	-10.70	QP	
3	0.3460	31.46	19.91	51.37	59.06	-7.69	QP	
4	0.4220	11.15	19.94	31.09	47.41	-16.32	AVG	
5	0.4380	29.72	19.95	49.67	57.10	-7.43	QP	
6	0.6820	27.65	20.03	47.68	56.00	-8.32	QP	
7	0.6940	8.19	20.04	28.23	46.00	-17.77	AVG	
8	1.0140	6.18	20.12	26.30	46.00	-19.70	AVG	
9	17.9820	17.34	20.31	37.65	50.00	-12.35	AVG	
10	18.3020	26.69	20.31	47.00	60.00	-13.00	QP	
11	21.3980	30.66	20.32	50.98	60.00	-9.02	QP	
12	22.0540	15.29	20.32	35.61	50.00	-14.39	AVG	

Note: Result=Reading+Factor Over Limit=Result-Limit

Conducted Emission Test Data

Test Site: 1# Shielded Room
 Test Specification: AC 230V, 50Hz
 Comment: Neutral Line
 Temp.: 22.2°C Hum.: 60%

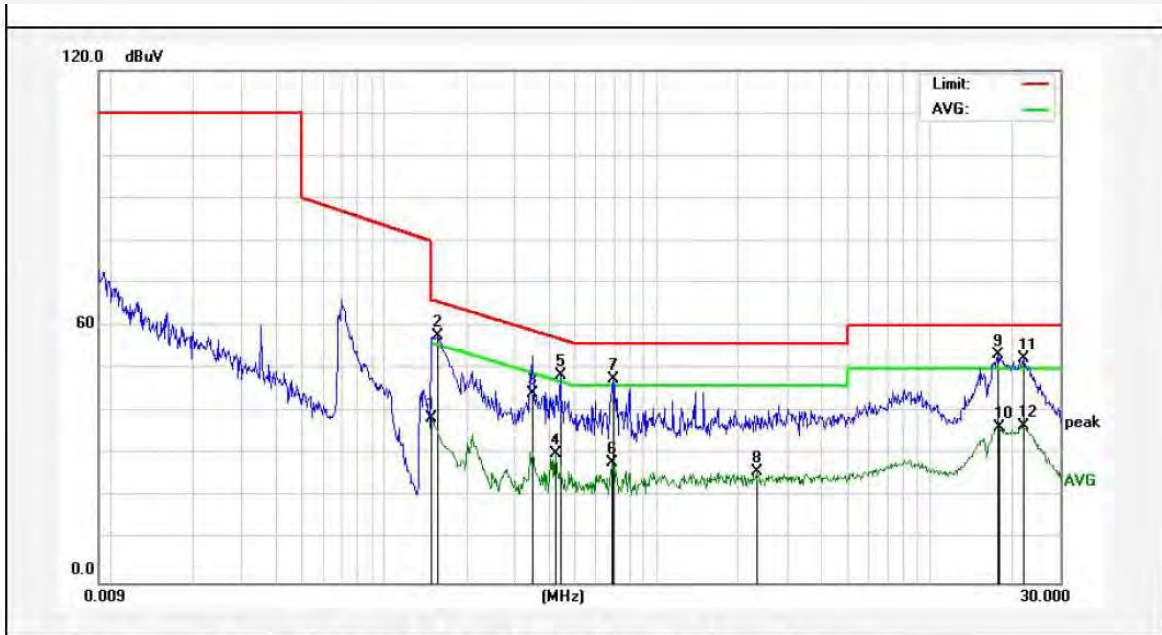

No.	Freq. (MHz)	Reading (dBuV)	Factor (dB)	Result (dBuV)	Limit dBuV	Over Limit (dB)	Detector	Remark
1	0.1500	18.58	19.90	38.48	55.99	-17.51	AVG	
2	0.1580	37.93	19.90	57.83	65.56	-7.73	QP	
3	0.3500	24.31	19.91	44.22	58.96	-14.74	QP	
4	0.4260	10.16	19.95	30.11	47.33	-17.22	AVG	
5	0.4420	28.48	19.95	48.43	57.02	-8.59	QP	
6	0.6860	8.10	20.04	28.14	46.00	-17.86	AVG	
7	0.6940	27.54	20.04	47.58	56.00	-8.42	QP	
8	2.3140	5.71	20.15	25.86	46.00	-20.14	AVG	
9	17.7820	32.87	20.30	53.17	60.00	-6.83	QP	
10	17.9580	16.27	20.31	36.58	50.00	-13.42	AVG	
11	22.0860	31.98	20.31	52.29	60.00	-7.71	QP	
12	22.0860	16.31	20.31	36.62	50.00	-13.38	AVG	

Note: Result=Reading+Factor Over Limit=Result-Limit

3. Radiated Emission Test

3.1. Test Standard and Limit

Test Standard	EN 55015
---------------	----------

Radiated Emission Test Limit

Test Limit	Frequency (MHz)	DISTANCE (Meters)	FIELD STRENGTHS LIMIT (dB μ V/m)
	30 ~ 230	3	40
	230 ~ 300	3	47

Remark: (1) The smaller limit shall apply at the combination point between two frequency bands.
(2) Distance refers to the distance in meters between the measuring instrument antenna and the closed point of any part of the EUT.

3.2. Test Setup

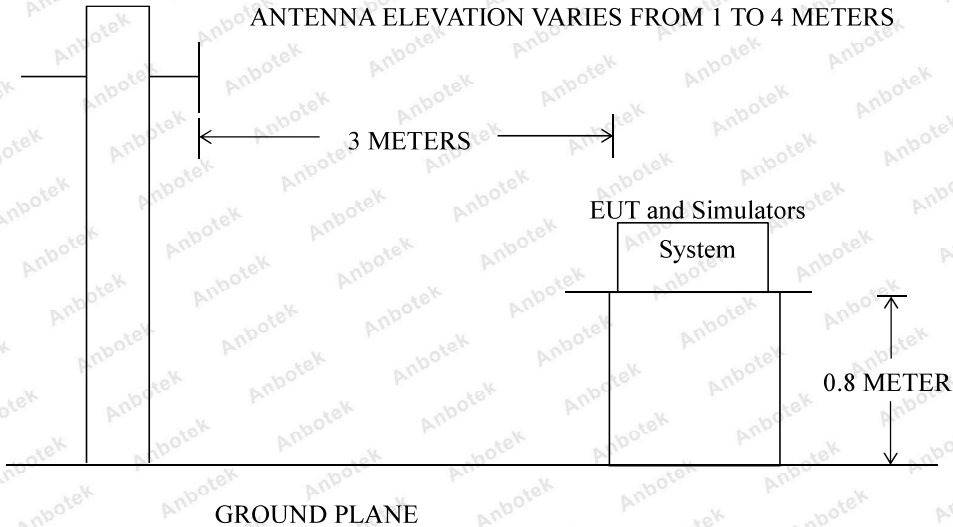

3.3. EUT Configuration on Measurement

The EN 55015 regulations test method must be used to find the maximum emission during radiated emission measurement.

3.4. Operating Condition of EUT

- 3.4.1. Setup the EUT as shown in Section 3.2.
- 3.4.2. Turn on the power of all equipments.
- 3.4.3. Let the EUT work in test mode and measure it.

3.5. Test Procedure

The EUT is placed on a turn table which is 0.8 meter high above the ground. The turn table can rotate 360 degrees to determine the position of the maximum emission level. The EUT is set 3 meters away from the receiving antenna which is mounted on an antenna tower. The antenna can be moved up and down from 1 to 4 meters to find out the maximum emission level. Bilog antenna is used as a receiving antenna. Both horizontal and vertical polarization of the antenna are set on test.

The bandwidth of the Receiver (ESCI) is set at 120kHz.

The EUT is tested in Chamber.

The test results are listed in Section 3.6.

3.6. Test Results

PASS

The frequency range from 30MHz to 300MHz is investigated.

The test curves are shown in the following pages.

Test item: Radiation Test **Polarization:** Horizontal
Standard: (RE)EN55015 **Power Source:** AC 230V, 50Hz
Distance: 3m **Temp.(°C)/Hum.(%RH):** 24.3(°C)/55%RH



No.	Freq. (MHz)	Reading (dBuV/m)	Factor (dB/m)	Result (dBuV/m)	Limit (dBuV/)	Over Limit (dB)	Detector	Height (cm)	degree (deg)	Remark
1	34.9238	40.51	-14.58	25.93	40.00	-14.07	peak			
2	56.2498	43.57	-15.05	28.52	40.00	-11.48	peak			
3	83.9694	52.96	-20.67	32.29	40.00	-7.71	peak			
4	97.0781	53.67	-20.92	32.75	40.00	-7.25	peak			
5	105.2256	52.59	-20.70	31.89	40.00	-8.11	peak			
6	198.2080	47.42	-20.88	26.54	40.00	-13.46	peak			

Note: **Result=Reading+Factor** **Over Limit=Result-Limit**

Test item: Radiation Test **Polarization:** Vertical
Standard: (RE)EN55015 **Power Source:** AC 230V, 50Hz
Distance: 3m **Temp.(°C)/Hum.(%RH):** 24.3(°C)/55%RH



No.	Freq. (MHz)	Reading (dBuV/m)	Factor (dB/m)	Result (dBuV/m)	Limit (dBuV/m)	Over Limit (dB)	Detector	Height (cm)	degree (deg)	Remark
1	30.0000	50.20	-16.95	33.25	40.00	-6.75	QP	100	0	
2	39.8218	43.06	-11.00	32.06	40.00	-7.94	QP	100	0	
3	50.3032	48.29	-14.59	33.70	40.00	-6.30	QP	100	0	
4	57.0323	49.07	-15.11	33.96	40.00	-6.04	QP	100	360	
5	74.8378	51.08	-20.56	30.52	40.00	-9.48	peak			
6	239.3984	45.90	-14.12	31.78	47.00	-15.22	peak			

Note: Result=Reading+Factor Over Limit=Result-Limit

4. Magnetic Radiated Emission Test

4.1. Test Standard and Limit

Test Standard	EN 55015
---------------	----------

Limits for Magnetic Radiated Emission

Test Limit	Frequency	Limits for loop diameter (dB μ A)
		2m
	9KHz ~ 70KHz	88
	70KHz ~ 150KHz	88 ~ 58*
	150KHz ~ 3.0MHz	58 ~ 22*
	3.0MHz ~ 30MHz	22

Note: (1) At the transition frequency the lower limit applies.
(2) * decreasing linearly with logarithm of the frequency.

4.2. Test Setup

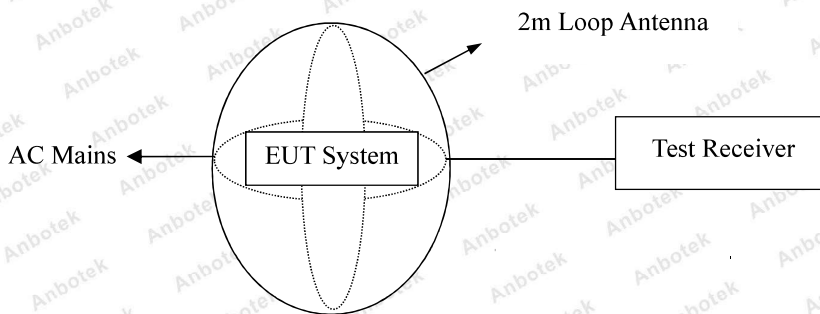

4.3. EUT Configuration on Measurement

The following equipments are installed on Magnetic Radiated emission Measurement to meet EN 55015 requirements and operating in a manner which tends to maximize its emission characteristics in a normal application.

4.4. Operating Condition of EUT

- 4.4.1. Setup the EUT as shown in Section 4.2.
- 4.4.2. Turn on the power of all equipments.
- 4.4.3. Let the EUT work in test mode and measure it.

4.5. Test Procedure

The EUT is placed on a wood table in the center of a loop antenna. The induced current in the loop antenna is measured by means of a current probe and the test receiver. Three field components are checked by means of a coaxial switch.

The frequency range from 9KHz to 30MHz is investigated. The receiver is measured with the quasi-peak detector. For frequency band 9KHz to 150KHz, the bandwidth of the test receiver (ESCI) is set at 200Hz. For frequency band 150KHz to 30MHz, the bandwidth is set at 9KHz.

All the test results are listed in Section 4.6.

4.6. Test Results

PASS

The frequency range from 9KHz to 30MHz is investigated.

The test curves are shown in the following pages.

Magnetic Radiated Emission Test

Test Site: 1# Shielded Room

Test Specification: AC 230V, 50Hz

Comment: X

Temp.: 22.2°C Hum.: 59%

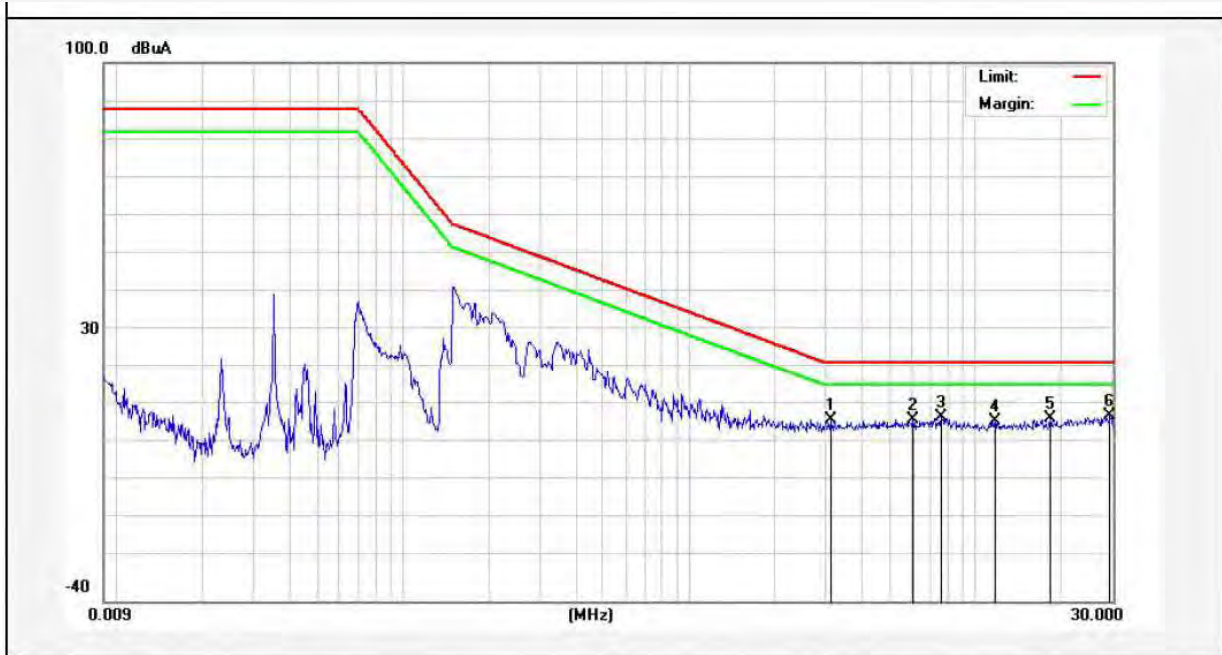

No.	Freq. (MHz)	Reading (dBuA)	Factor (dB)	Result (dBuA)	Limit dBuA	Over Limit (dB)	Detector	Remark
1	3.1060	6.90	0.02	6.92	22.00	-15.08	QP	
2	6.0220	7.14	0.06	7.20	22.00	-14.80	QP	
3	7.5580	7.87	0.07	7.94	22.00	-14.06	QP	
4	11.6820	6.66	0.01	6.67	22.00	-15.33	QP	
5	18.2139	7.53	0.02	7.55	22.00	-14.45	QP	
6	29.4660	7.95	0.02	7.97	22.00	-14.03	QP	

Note: **Result=Reading+Factor Over Limit=Result-Limit**

Magnetic Radiated Emission Test

Test Site: 1# Shielded Room
 Test Specification: AC 230V, 50Hz
 Comment: Y
 Temp.: 22.2°C Hum.: 59%

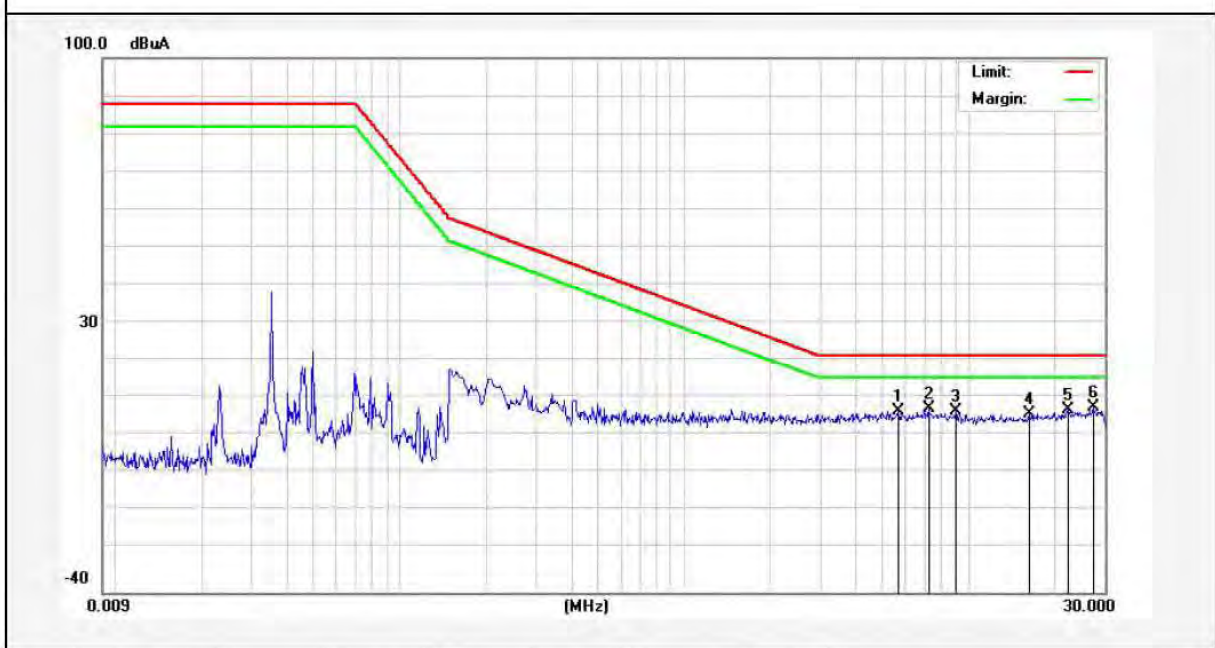

No.	Freq. (MHz)	Reading (dBuA)	Factor (dB)	Result (dBuA)	Limit dBuA	Over Limit (dB)	Detector	Remark
1	5.6579	7.48	0.05	7.53	22.00	-14.47	QP	
2	7.2380	8.03	0.07	8.10	22.00	-13.90	QP	
3	9.0180	7.35	0.03	7.38	22.00	-14.62	QP	
4	16.2939	6.80	0.02	6.82	22.00	-15.18	QP	
5	22.2740	7.66	0.02	7.68	22.00	-14.32	QP	
6	27.3460	8.59	0.02	8.61	22.00	-13.39	QP	

Note: Result=Reading+Factor Over Limit=Result-Limit

Magnetic Radiated Emission Test

Test Site: 1# Shielded Room
 Test Specification: AC 230V, 50Hz
 Comment: Z
 Temp.: 22.2°C Hum.: 59%

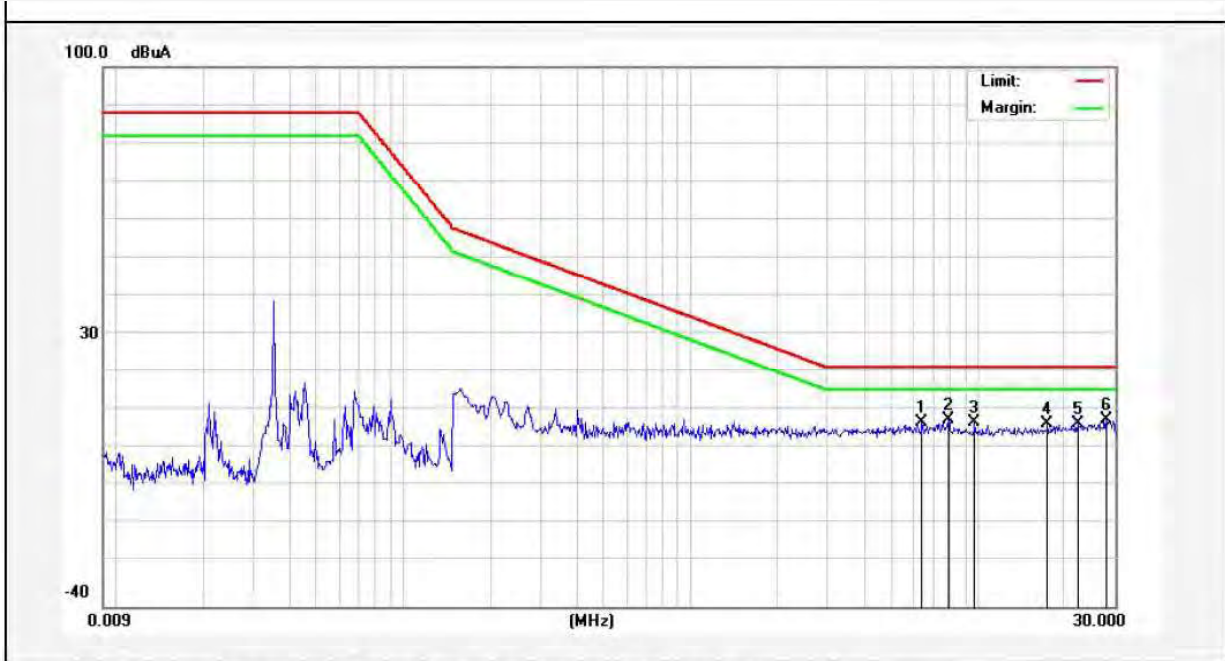

No.	Freq. (MHz)	Reading (dBuA)	Factor (dB)	Result (dBuA)	Limit dBuA	Over Limit (dB)	Detector	Remark
1	6.4140	7.76	0.07	7.83	22.00	-14.17	QP	
2	7.8740	8.46	0.06	8.52	22.00	-13.48	QP	
3	9.7780	7.89	0.02	7.91	22.00	-14.09	QP	
4	17.5419	7.35	0.02	7.37	22.00	-14.63	QP	
5	22.2300	7.33	0.02	7.35	22.00	-14.65	QP	
6	27.9540	8.55	0.02	8.57	22.00	-13.43	QP	

Note: Result=Reading+Factor Over Limit=Result-Limit

5. Harmonic Current Emission Test

5.1. Test Standard

Test Standard	EN 61000-3-2
---------------	--------------

5.2. Test Setup

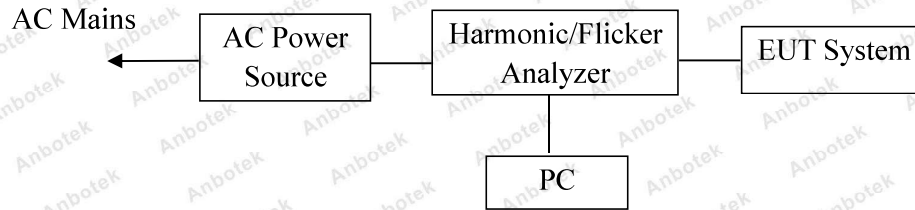

5.3. Operating Condition of EUT

5.3.1. Setup the EUT as shown on Section 5.2.

5.3.2. Turn on the power of all equipments.

5.3.3. After that, let the EUT work in test mode measure it.

5.4. Test Results

PASS

The test curves are shown in the following pages.

Harmonic Current Test Result Summary (Run time)

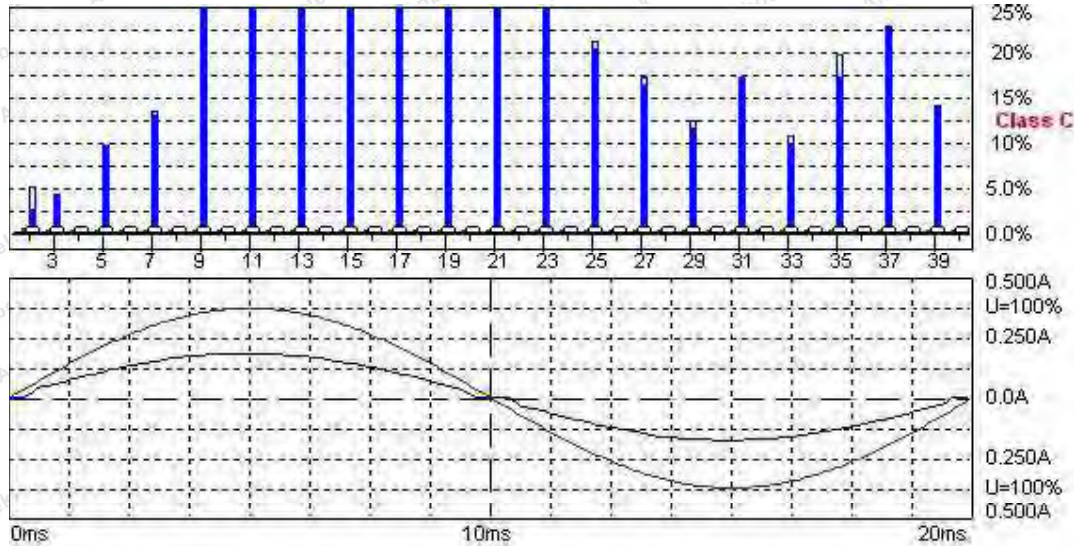

Harmonic Emission - IEC 61000-3-2 , EN 61000-3-2 , (EN60555-2)

Urms = 229.5 V P = 28.90 W THC = 0.005 A Range: 0.5 A
 Irms = 0.126 A pf = 0.998 H1max = 0.126 A V-nom: 230 V

Test aborted, Result: PASSED

HAP-1000 EMC-Partner

Full Bar : Actual Values
Empty Bar : Maximum Values
Blue : Current , Green : Voltage , Red : Failed

Harmonic Current Test Result Summary (Run time)

Urms = 229.5V Freq = 50.000 Range: 0.5 A
 Irms = 0.126A Ipk = 0.185A cf = 1.464
 P = 28.90W S = 28.97VA pf = 0.998
 THDi = 3.90 % THDu = 0.10 % Class C

Test - Time : 3min (100 %)

Limit Reference: H1(max)= 0.1259A pf(max)= 1.000

Order	Freq. [Hz]	Iavg [A]	Iavg%L [%]	Irms [A]	Irms% [%]	Irms%L [%]	Imax [A]	Imax%L [%]	Limit [A]	Status
1	50	0.1259		0.1259	99.734		0.1259			
2	100	0.0000	0.0000	0.0001	0.0484	2.4240	0.0001	4.8481	0.0025	
3	150	0.0000	0.0000	0.0015	1.1847	3.9593	0.0015	3.9593	0.0378	
4	200	0.0000		0.0000	0.0000		0.0000			
5	250	0.0000	0.0000	0.0012	0.9429	9.4538	0.0012	9.4538	0.0126	
6	300	0.0000		0.0000	0.0000		0.0000			
7	350	0.0000	0.0000	0.0011	0.8946	12.813	0.0011	13.159	0.0088	
8	400	0.0000		0.0000	0.0000		0.0000			
9	450	0.0000	0.0000	0.0018	1.4265	28.604	0.0018	28.604	0.0063	
10	500	0.0000		0.0000	0.0000		0.0000			
11	550	0.0000	0.0000	0.0012	0.9671	32.321	0.0012	32.321	0.0038	
12	600	0.0000		0.0000	0.0000		0.0000			
13	650	0.0000	0.0000	0.0013	1.0155	33.937	0.0013	34.745	0.0038	
14	700	0.0000		0.0000	0.0000		0.0000			
15	750	0.0000	0.0000	0.0018	1.4507	48.481	0.0018	48.481	0.0038	
16	800	0.0000		0.0000	0.0000		0.0000			
17	850	0.0000	0.0000	0.0012	0.9671	32.321	0.0012	32.321	0.0038	
18	900	0.0000		0.0000	0.0000		0.0000			
19	950	0.0000	0.0000	0.0009	0.7495	25.048	0.0010	26.664	0.0038	
20	1000	0.0000		0.0000	0.0000		0.0000			
21	1050	0.0000	0.0000	0.0015	1.1605	38.785	0.0015	39.593	0.0038	
22	1100	0.0000		0.0000	0.0000		0.0000			
23	1150	0.0000	0.0000	0.0012	0.9429	31.513	0.0012	31.513	0.0038	
24	1200	0.0000		0.0000	0.0000		0.0000			
25	1250	0.0000	0.0000	0.0008	0.6044	20.200	0.0008	21.008	0.0038	
26	1300	0.0000		0.0000	0.0000		0.0000			
27	1350	0.0000	0.0000	0.0006	0.4836	16.160	0.0006	16.968	0.0038	
28	1400	0.0000		0.0000	0.0000		0.0000			
29	1450	0.0000	0.0000	0.0004	0.3385	11.312	0.0005	12.120	0.0038	
30	1500	0.0000		0.0000	0.0000		0.0000			
31	1550	0.0000	0.0000	0.0006	0.5077	16.968	0.0006	16.968	0.0038	
32	1600	0.0000		0.0000	0.0000		0.0000			
33	1650	0.0000	0.0000	0.0004	0.2901	9.6962	0.0004	10.504	0.0038	
34	1700	0.0000		0.0000	0.0000		0.0000			
35	1750	0.0000	0.0000	0.0006	0.5077	16.968	0.0007	19.392	0.0038	
36	1800	0.0000		0.0000	0.0000		0.0000			
37	1850	0.0000	0.0000	0.0009	0.6770	22.624	0.0009	22.624	0.0038	
38	1900	0.0000		0.0000	0.0000		0.0000			
39	1950	0.0000	0.0000	0.0005	0.4110	13.736	0.0005	13.736	0.0038	
40	2000	0.0000		0.0000	0.0000		0.0000			

6. Voltage Fluctuations & Flicker Test

6.1. Test Standard

Test Standard	EN 61000-3-3
---------------	--------------

6.2. Test Setup

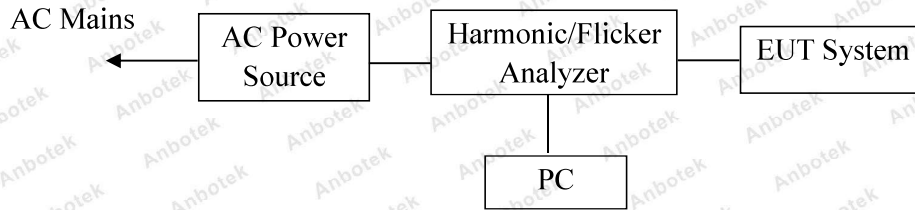

6.3. Operating Condition of EUT

6.3.1. Setup the EUT as shown on Section 6.2.

6.3.2. Turn on the power of all equipments.

6.3.3. After that, let the EUT work in test mode measure it.

6.4. Test Results

PASS

The test curves are shown in the following pages.

Flicker Test Summary per EN/IEC61000-3-3 (Run time)

Flicker Emission IEC 61000-4-15 for 230V/50Hz

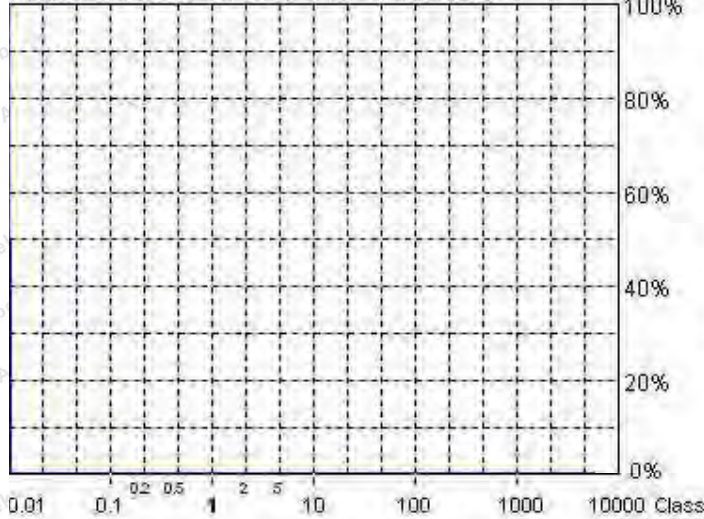

Actual Flicker (Fli):	0.00
Short-term Flicker (Pst):	0.07
Limit (Pst):	1.00
Long-term Flicker (Plt):	0.00
Limit (Plt):	0.65
Maximum Relative Volt. Change (dmax):	0.00%
Limit (dmax):	4.00%
Relative Steady-state Voltage Change (dc):	0.00%
Limit (dc):	3.30%
Tmax 3.30% (dt):	0.00ms
Limit (dt>Lim):	500ms

Flicker Emission - IEC 61000-3-3, EN 61000-3-3

Urms = 229.5 V P = 28.89 W
Irms = 0.126 A pf = 0.997

Range: 0.5 A
V-nom: 230 V

Test aborted, Result: PASSED

HAR-1000 EMC-Partner

Full Bar : Actual Values
Empty Bar : Maximum Values
Circles : Average Values
Blue : Current , Green : Voltage , Red : Failed

Urms = 229.5V Freq = 50.000 Range: 0.5 A
Irms = 0.126A Ipk = 0.185A cf = 1.464
P = 28.89W S = 28.97VA pf = 0.997

Test - Time : 1 x 10min = 10min (100 %)

LIN (Line Impedance Network) : L: 0.24ohm +j0.15ohm N: 0.16ohm +j0.10ohm

Limits : Plt : 0.65 Pst : 1.00
dmax : 4.00 % dc : 3.30 %
dtLim: 3.30 % dt>Lim: 500ms

	dmax [%]	dc [%]	dt>Lim [ms]
1	0.000	0.000	0.000

7. Electrostatic Discharge Immunity Test

7.1. Test Standard and Level

Test Standard:	EN 61547 (IEC 61000-4-2)
Performance Criterion:	B
Severity Level: 3 / Air Discharge: ±8kV, Level: 2 / Contact Discharge: ±4kV	

Test Level

Level	Test Voltage Contact Discharge (kV)	Test Voltage Air Discharge (kV)
1.	±2	±2
2.	±4	±4
3.	±6	±8
4.	±8	±15
X	Special	Special

7.2. Test Setup

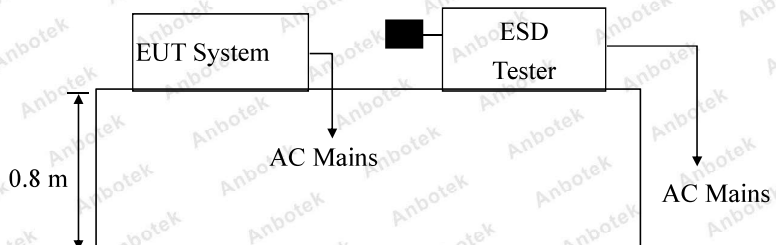

7.3. EUT Configuration on Measurement

The following equipments are installed on Electrostatic Discharge immunity Measurement to meet EN 61547 requirements and operating in a manner which tends to maximize its emission characteristics in a normal application.

7.4. Operating Condition of EUT

- 7.4.1. Setup the EUT as shown on Section 7.2.
- 7.4.2. Turn on the power of all equipments.
- 7.4.3. After that, let the EUT work in test mode measure it.

7.5. Test Procedure

7.5.1. Air Discharge:

This test is done on a non-conductive surface. The round discharge tip of the discharge electrode shall be approached as fast as possible to touch the EUT. After each discharge, the discharge electrode shall be removed from the EUT. The generator is then re-triggered for a new single discharge and repeated 10 times for each pre-selected test point. This procedure shall be repeated until all the air discharge completed.

7.5.2. Contact Discharge:

All the procedure shall be same as Section 7.5.1. except that the tip of the discharge electrode shall touch the EUT before the discharge switch is operated.

7.5.3. Indirect discharge for horizontal coupling plane

At least 20 single discharges shall be applied to the horizontal coupling plane, at points on each side of the EUT. The discharge electrode positions vertically at a distance of 0.1m from the EUT and with the discharge electrode touching the coupling plane.

7.5.4. Indirect discharge for vertical coupling plane

At least 20 single discharge shall be applied to the center of one vertical edge of the coupling plane. The coupling plane, of dimensions 0.5m × 0.5m, is placed parallel to, and positioned at a distance of 0.1m from the EUT. Discharges shall be applied to the coupling plane, with this plane in sufficient different positions that the four faces of the EUT are completely illuminated.

7.6. Test Results

PASS

Please refer to the following page.

Electrostatic Discharge Test Results

Shenzhen Anbotek Compliance Laboratory Limited

Air discharge :	±8.0kV	Temperature :	24℃
Contact discharge :	±4.0kV	Humidity :	53%
Power Supply :	AC 230V, 50Hz	Criterion required :	B
Test Result :	<input checked="" type="checkbox"/> Pass <input type="checkbox"/> Fail		
# For each point positive 10 times and negative 10 times discharge			
Location			
		Kind A-Air Discharge C-Contact Discharge	Result
Slot of the EUT	14 points	A	<input checked="" type="checkbox"/> A <input type="checkbox"/> B <input type="checkbox"/> C <input type="checkbox"/> D
Others	10 points	A	<input checked="" type="checkbox"/> A <input type="checkbox"/> B <input type="checkbox"/> C <input type="checkbox"/> D
HCP	4 points	C	<input checked="" type="checkbox"/> A <input type="checkbox"/> B <input type="checkbox"/> C <input type="checkbox"/> D
VCP of the front	4 points	C	<input checked="" type="checkbox"/> A <input type="checkbox"/> B <input type="checkbox"/> C <input type="checkbox"/> D
VCP of the rear	4 points	C	<input checked="" type="checkbox"/> A <input type="checkbox"/> B <input type="checkbox"/> C <input type="checkbox"/> D
VCP of the left	4 points	C	<input checked="" type="checkbox"/> A <input type="checkbox"/> B <input type="checkbox"/> C <input type="checkbox"/> D
VCP of the right	4 points	C	<input checked="" type="checkbox"/> A <input type="checkbox"/> B <input type="checkbox"/> C <input type="checkbox"/> D
Note: Discharge should be considered on Contact and Air and Horizontal Coupling Plane (HCP) and Vertical Coupling Plane (VCP).			

8. RF Field Strength Susceptibility Test

8.1. Test Standard and Level

Test Standard:	EN 61547 (IEC 61000-4-3)
Performance criterion:	A
Severity Level 2: 3V/m	

Test Level

Level	Field Strength V/m
1.	1
2.	3
3.	10
X.	Special

8.2. Test Setup

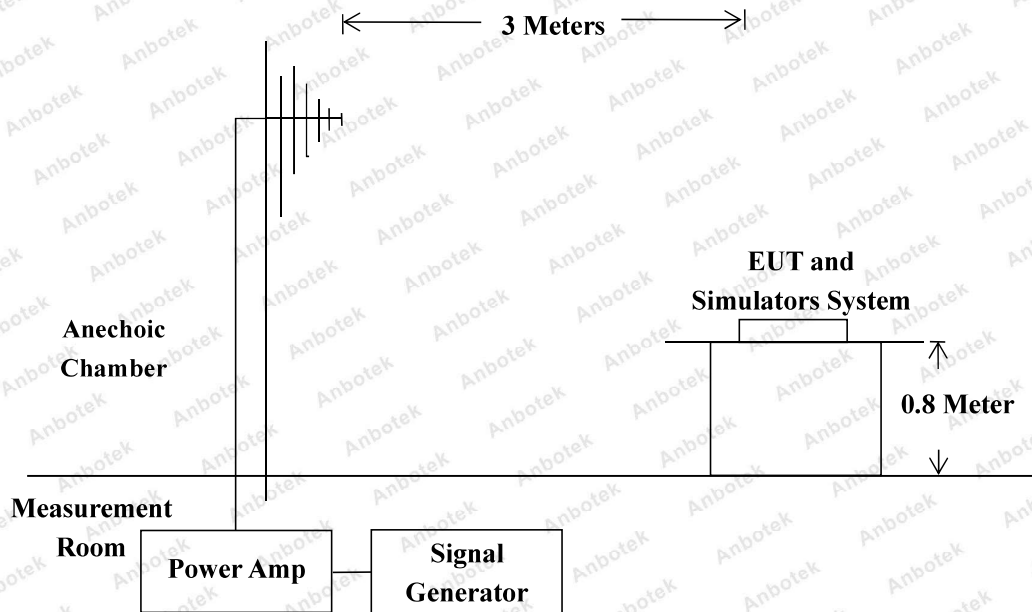

8.3. EUT Configuration on Measurement

The following equipments are installed on RF Field Strength susceptibility Measurement to meet EN 61547 requirements and operating in a manner which tends to maximize its emission characteristics in a normal application.

8.4. Operating Condition of EUT

- 8.4.1. Setup the EUT as shown on Section 8.2.
- 8.4.2. Turn on the power of all equipments.
- 8.4.3. After that, let the EUT work in test mode measure it.

8.5. Test Procedure

The EUT and its simulators are placed on a turn table which is 0.8 meter above ground. EUT is set 3 meter away from the transmitting antenna which is mounted on an antenna tower. Both horizontal and vertical polarization of the antenna are set on test. Each of the four sides of EUT must be faced this transmitting antenna and measured individually. In order to judge the EUT performance, a CCD camera is used to monitor EUT screen. All the scanning conditions are as follow:

Condition of Test	Remarks
Fielded Strength	3 V/m (Severity Level 2)
Radiated Signal	Unmodulated
Scanning Frequency	80 - 1000 MHz
Dwell time of radiated	0.0015 decade/s
Waiting Time	Remarks

8.6. Measuring Results

PASS

Please refer to the following page.

RF Field Strength Susceptibility Test Results

Shenzhen Anbotek Compliance Laboratory Limited

Field Strength :	3V/m	Temperature :	25°C
Criterion required :	A	Humidity :	55%
Power Supply :	AC 230V, 50Hz	Test Result :	<input checked="" type="checkbox"/> Pass <input type="checkbox"/> Fail
Modulation : <input checked="" type="checkbox"/> AM 1 KHz 80% <input type="checkbox"/> Pulse <input type="checkbox"/> none			
Azimuth	Horizontal	Vertical	Result
Front	3V/m	3V/m	<input checked="" type="checkbox"/> A <input type="checkbox"/> B <input type="checkbox"/> C <input type="checkbox"/> D
Right	3V/m	3V/m	<input checked="" type="checkbox"/> A <input type="checkbox"/> B <input type="checkbox"/> C <input type="checkbox"/> D
Rear	3V/m	3V/m	<input checked="" type="checkbox"/> A <input type="checkbox"/> B <input type="checkbox"/> C <input type="checkbox"/> D
Left	3V/m	3V/m	<input checked="" type="checkbox"/> A <input type="checkbox"/> B <input type="checkbox"/> C <input type="checkbox"/> D
<p>Note: The Project was tested in Shenzhen EMTEK Co., Ltd.</p>			

9. Electrical Fast Transient/Burst Immunity Test

9.1. Test Standard and Level

Test Standard:	EN 61547 (IEC 61000-4-4)
Performance criterion:	B
Severity Level 2: 1.00kV	

Test Level

Open Circuit Output Test Voltage $\pm 10\%$		
Level	On Power Supply Lines (kV)	On I/O (Input/Output) Signal data and control lines (kV)
1.	0.50	0.25
2.	1.00	0.50
3.	2.00	1.00
4.	4.00	2.00
X.	Special	Special

9.2. Test Setup

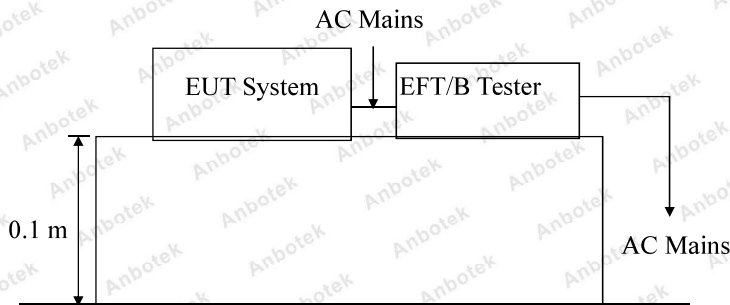

9.3. EUT Configuration on Measurement

The following equipments are installed on Electrical Fast Transient/Burst Immunity Measurement to meet EN 61547 requirements and operating in a manner which tends to maximize its emission characteristics in a normal application.

9.4. Operating Condition of EUT

- 9.4.1. Setup the EUT as shown in Section 9.2.
- 9.4.2. Turn on the power of all equipments.
- 9.4.3. Let the EUT work in test mode and measure it.

9.5. Test Procedure

The EUT is put on the table which is 0.1 meter high above the ground. This reference ground plane shall project beyond the EUT by at least 0.1m on all sides and the minimum distance between EUT and all other conductive structure, except the ground plane beneath the EUT, shall be more than 0.5m.

9.5.1. For input and output AC power ports:

The EUT is connected to the power mains by using a coupling device which couples the EFT interference signal to AC power lines. Both polarities of the test voltage should be applied during compliance test and the duration of the test is 2 mins.

9.5.2. For signal lines and control lines ports:

It's unnecessary to test.

9.5.3. For DC output line ports:

It's unnecessary to test.

9.6. Test Results

PASS

Please refer to the following page.

Electrical Fast Transient/Burst Test Results

Shenzhen Anbotek Compliance Laboratory Limited

Ambient Condition : 25°C / 56% RH		Criterion required : B	
Power Supply : AC 230V, 50Hz		Test Result : <input checked="" type="checkbox"/> Pass <input type="checkbox"/> Fail	
Inject Line : AC Mains		Inject Method: Direct	Inject Time(s): 120
Line	Polarity	Test Voltage (kV)	Result
AC Line	±	1.00kV	<input checked="" type="checkbox"/> A <input type="checkbox"/> B <input type="checkbox"/> C <input type="checkbox"/> D
DC Line			
Signal Line			

10. Surge Immunity Test

10.1. Test Standard and Level

Test Standard:	EN 61547 (IEC 61000-4-5)
Performance criterion:	B
Severity Level 2, Line to Line: 1.0kV	

Test Level

Severity Level	Open-Circuit Test Voltage (kV)
1.	0.5
2.	1.0
3.	2.0
4.	4.0
X.	Special

10.2. Test Setup

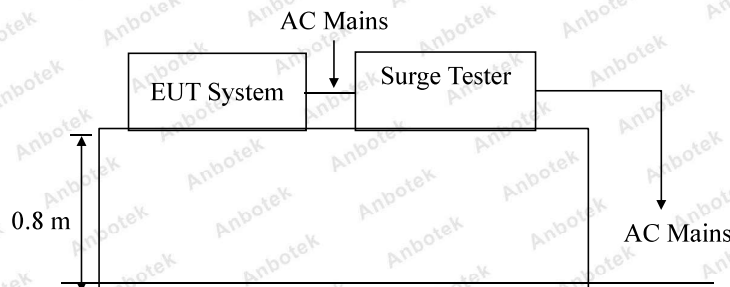

10.3. EUT Configuration on Measurement

The following equipments are installed on Surge immunity Measurement to meet EN 61547 requirements and operating in a manner which tends to maximize its emission characteristics in a normal application.

10.4. Operating Condition of EUT

10.4.1. Setup the EUT as shown in Section 10.2.

10.4.2. Turn on the power of all equipments.

10.4.3. Let the EUT work in test mode and measure it.

10.5. Test Procedure

- 10.5.1. Set up the EUT and test generator as shown on Section 10.2.
- 10.5.2. For line to line coupling mode, provide a 1.0 kV 1.2/50us voltage surge (at open-circuit condition) and 8/20us current surge to EUT selected points.
- 10.5.3. At least 5 positive and 5 negative (polarity) tests with a maximum 1/min repetition rate are conducted during test.
- 10.5.4. Different phase angles are done individually.
- 10.5.5. Record the EUT operating situation during compliance test and decide the EUT immunity criterion for above each test.

10.6. Test Results

PASS

Please refer to the following page.

Surge Immunity Test Results

Shenzhen Anbotek Compliance Laboratory Limited

Humidity :	56%	Temperature :	25℃		
Power Supply :	AC 230V, 50Hz	Criterion required:	B		
Test Result :	<input checked="" type="checkbox"/> Pass <input type="checkbox"/> Fail				
Location	Polarity	Phase Angle	Number of Pulse	Pulse Voltage (kV)	Result
L-N	±	<input type="checkbox"/> 0° <input checked="" type="checkbox"/> 90° <input type="checkbox"/> 180° <input checked="" type="checkbox"/> 270°	5	1.0kV	<input checked="" type="checkbox"/> A <input type="checkbox"/> B <input type="checkbox"/> C <input type="checkbox"/> D
L-PE					
N-PE					

11. Injected Currents Susceptibility Test

11.1. Test Standard and Level

Test Standard:	EN 61547 (IEC 61000-4-6)
Performance criterion:	A
Severity Level 2: 3V (rms), (0.15MHz~80MHz)	

Test Level

Level	Field Strength V
1.	1
2.	3
3.	10
X.	Special

11.2. Test Setup

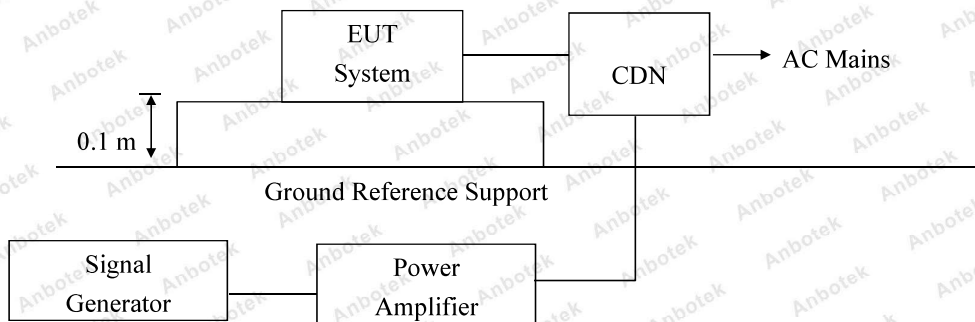

11.3. EUT Configuration

The following equipments are installed on currents susceptibility Measurement to meet EN 61547 requirements and operating in a manner which tends to maximize its emission characteristics in a normal application.

11.4. Operating Condition of EUT

11.4.1. Setup the EUT as shown in Section 11.2.

11.4.2. Turn on the power of all equipments.

11.4.3. Let the EUT work in test mode and measure it.

11.5. Test Procedure

- 1) Set up the EUT, CDN and test generators as shown on Section 11.2.
- 2) Let the EUT work in test mode and measure it.
- 3) The EUT are placed on an insulating support 0.1m high above a ground reference plane. CDN (coupling and decoupling device) is placed on the ground plane about 0.3m from EUT. Cables between CDN and EUT are as short as possible, and their height above the ground reference plane shall be between 30 and 50 mm (where possible).
- 4) The disturbance signal described below is injected to EUT through CDN.
- 5) The EUT operates within its operational mode(s) under intended climatic conditions after power on.
- 6) The frequency range is swept from 150KHz to 80MHz using 3V signal level, and with the disturbance signal 80% amplitude modulated with a 1KHz sine wave.
- 7) The rate of sweep shall not exceed 1.5×10^{-3} decades/s. Where the frequency is swept incrementally, the step size shall not exceed 1% of the start and thereafter 1% of the preceding frequency value.
- 8) Recording the EUT operating situation during compliance testing and decide the EUT immunity criterion.

11.6. Test Results

PASS

Please refer to the following page.

Injected Currents Susceptibility Test Results

Shenzhen Anbotek Compliance Laboratory Limited

Humidity : 56%		Temperature : 24°C	
Power Supply : AC 230V, 50Hz		Criterion required: A	
Test Result : <input checked="" type="checkbox"/> Pass <input type="checkbox"/> Fail			
Frequency Range (MHz)	Injected Position	Strength (Unmodulated)	Result
0.15 ~ 80	AC Mains	3V	<input checked="" type="checkbox"/> A <input type="checkbox"/> B <input type="checkbox"/> C <input type="checkbox"/> D
Remark : 1. Modulation Signal:1KHz 80% AM			

12. Voltage Dips And Interruptions Test

12.1. Test Standard and Level

Test Standard:	EN 61547 (IEC 61000-4-11)
Performance Criterion:	B&C

Test Level

Test Level %UT	Voltage dip and short interruptions %UT	Duration (in period)
0	100	0.5
70	30	10 *

12.2. Test Setup

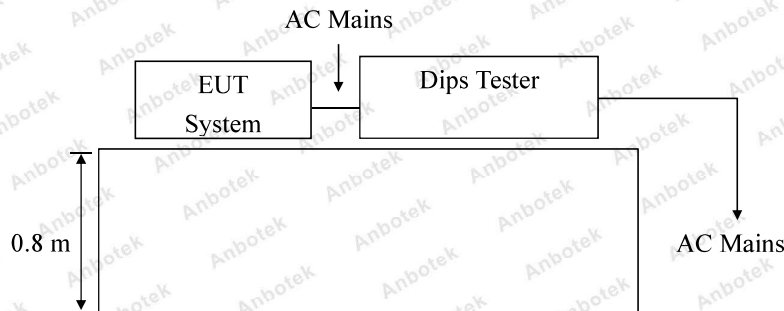

12.3. EUT Configuration on Measurement

The following equipments are installed on Voltage dips and interruptions Measurement to meet EN 61547 requirements and operating in a manner which tends to maximize its emission characteristics in a normal application.

12.4. Operating Condition of EUT

12.4.1. Setup the EUT as shown in Section 12.2.

12.4.2. Turn on the power of all equipments.

12.4.3. Let the EUT work in test mode and measure it.

12.5. Test Procedure

- 1) Set up the EUT and test generator as shown on Section 12.2.
- 2) The interruptions is introduced at selected phase angles with specified duration.
- 3) Record any degradation of performance.

12.6. Test Results

PASS

Please refer to the following page.

Voltage Dips and Interruptions Test Results

Shenzhen Anbotek Compliance Laboratory Limited

Temperature : 25°C		Humidity : 56%	
Power Supply : AC 230V, 50Hz		Criterion required : B&C	
Test Result : <input checked="" type="checkbox"/> Pass <input type="checkbox"/> Fail			
Test Level % UT	Voltage Dips & Short Interruptions % UT	Duration (in periods)	Result
0	100	0.5P	<input type="checkbox"/> A <input checked="" type="checkbox"/> B <input type="checkbox"/> C <input type="checkbox"/> D
70	30	10P	<input type="checkbox"/> A <input type="checkbox"/> B <input checked="" type="checkbox"/> C <input type="checkbox"/> D
Test Level % UT	Voltage Dips & Short Interruptions % UT	Duration (in periods)	Result

APPENDIX I -- TEST SETUP PHOTOGRAPH

Photo of Power Line Conducted Emission Test



Photo of Radiated Emission Test

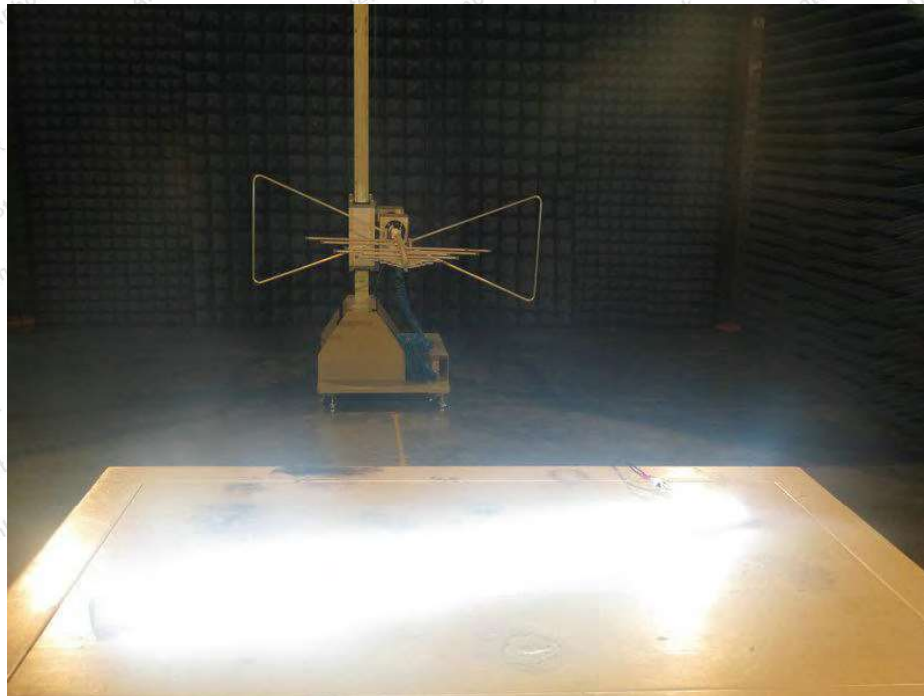

Photo of Magnetic Radiated Emission Test



Photo of Flicker/ Harmonic Test



Photo of Electrostatic Discharge Immunity Test

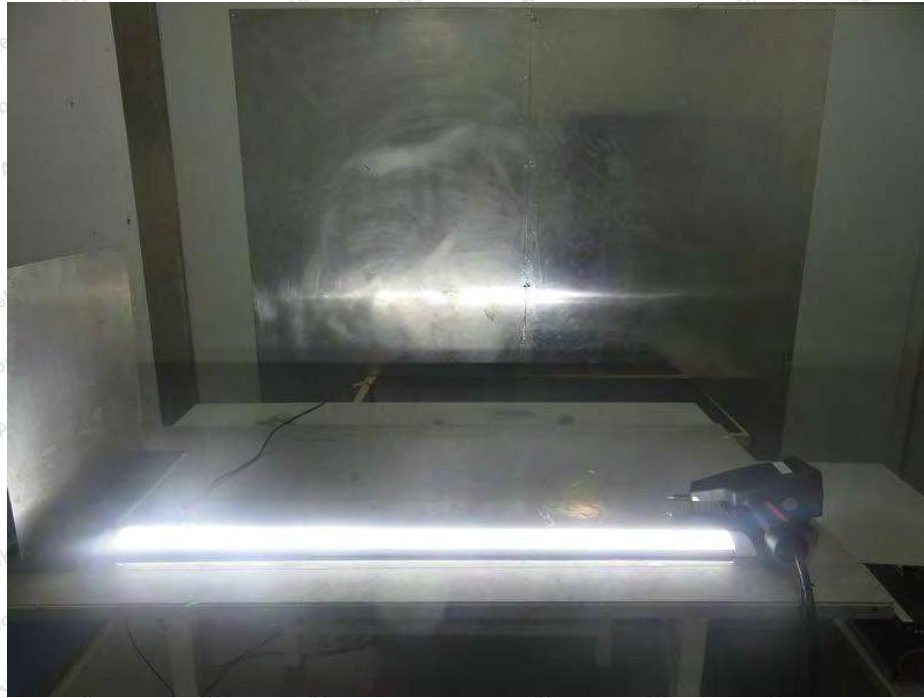

Photo of RF Field Strength susceptibility Test



Photo of Electrical Fast Transient/Burst Immunity Test



Photo of Surge Immunity Test



Photo of Injected currents susceptibility Test



Photo of Voltage Dips and Interruptions Test

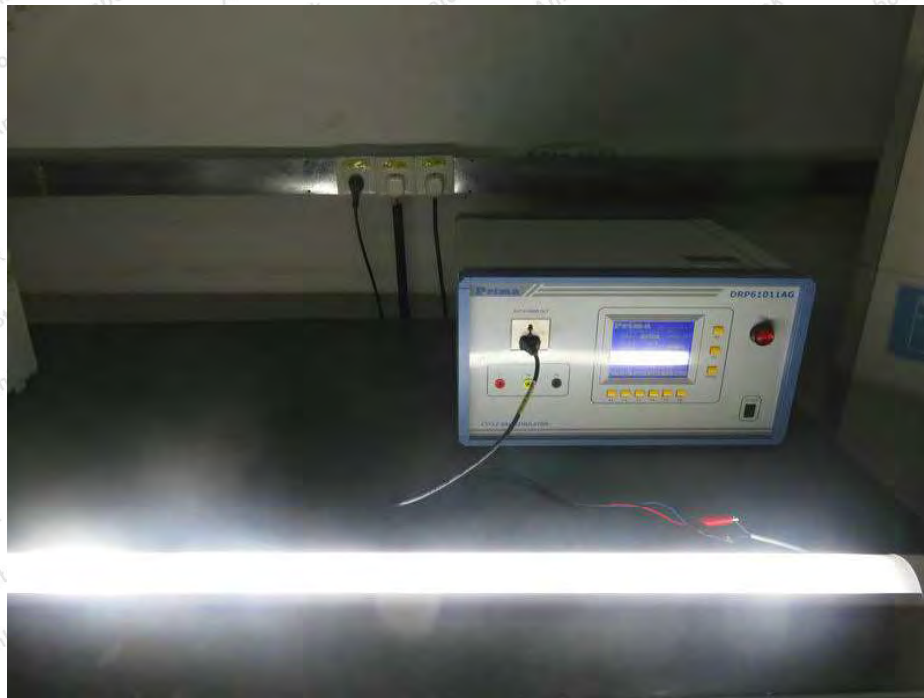

APPENDIX II -- EXTERNAL PHOTOGRAPH

Model No.: SL-LPT-1.2M



Model No.: SL-LPT-1.2M

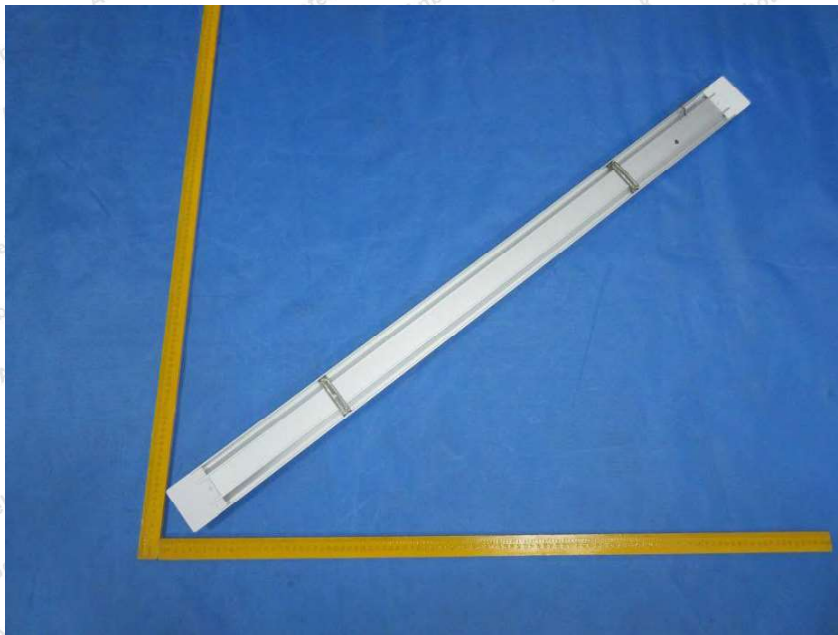

APPENDIX III -- INTERNAL PHOTOGRAPH

Model No.: SL-LPT-1.2M

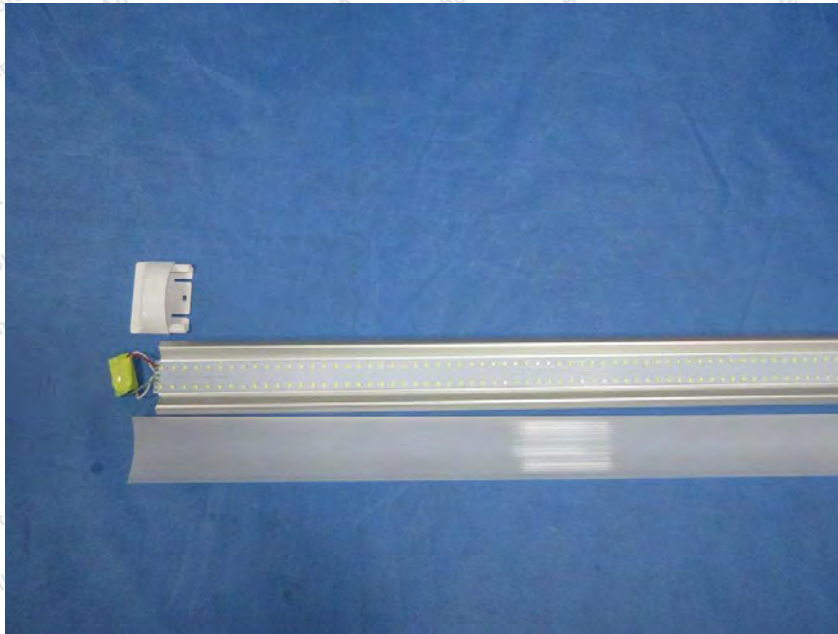

Model No.: SL-LPT-1.2M

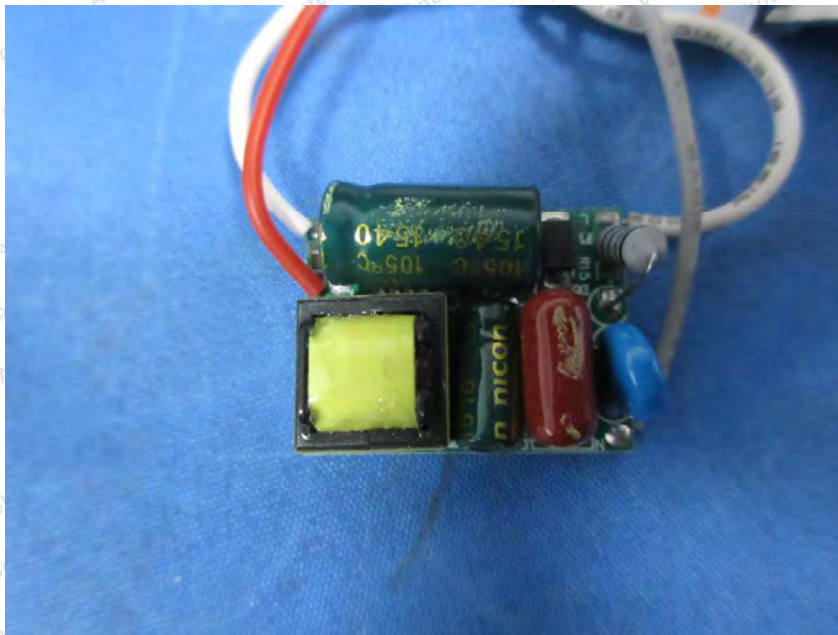

Model No.: SL-LPT-1.2M

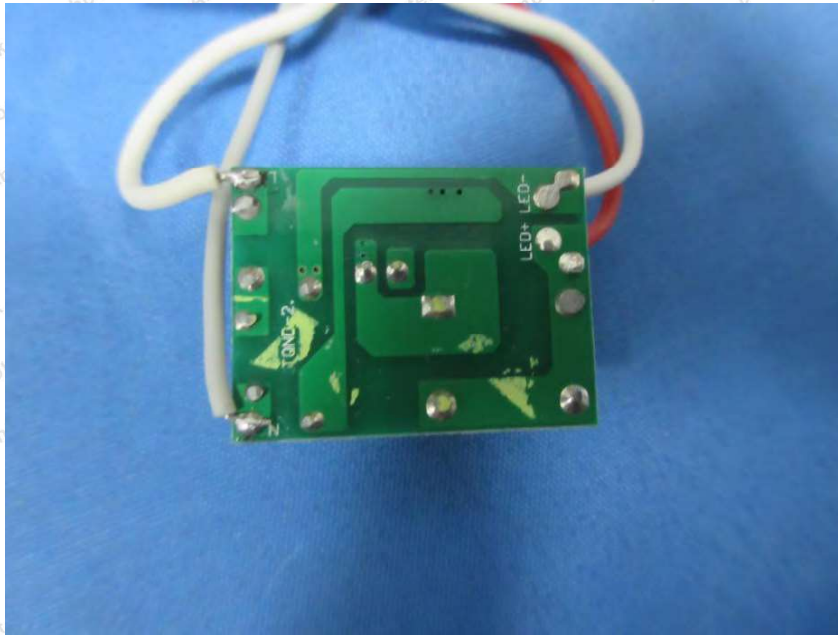

Model No.: SL-LPT-1.2M



CE Label

1. The CE conformity marking must consist of the initials 'CE' taking the following form:

If the CE marking is reduced or enlarged, the proportions given in the above graduated drawing must be respected.

2. The CE marking must have a height of at least 5 mm except where this is not possible on account of the nature of the apparatus.

3. The CE marking must be affixed to the product or to its data plate. Additionally it must be affixed to the packaging, if any, and to the accompanying documents.

4. The CE marking must be affixed visibly, legibly and indelibly.

It must have the same height as the initials 'CE'.

----- End of Report -----